

Grizzly Industrial, Inc.®

Digital Readout System MODEL H6087-H6098 OPERATION MANUAL

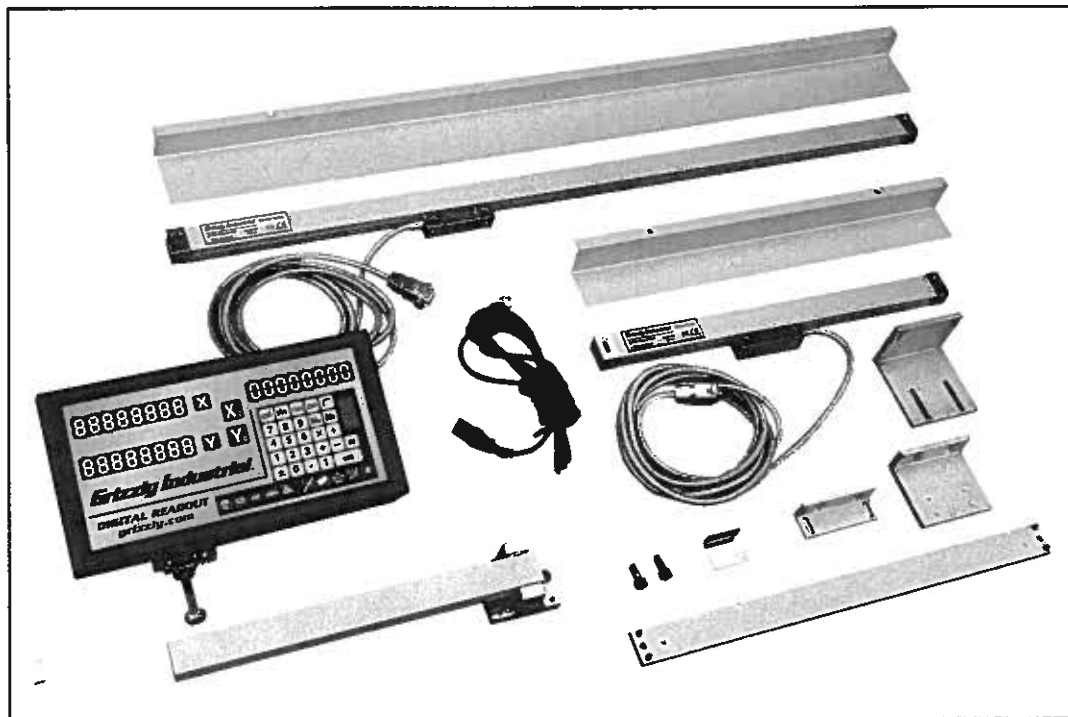

COPYRIGHT © JUNE, 2004 BY GRIZZLY INDUSTRIAL, INC.
WARNING: NO PORTION OF THIS MANUAL MAY BE REPRODUCED IN ANY SHAPE
OR FORM WITHOUT THE WRITTEN APPROVAL OF GRIZZLY INDUSTRIAL, INC.
#CA6351 PRINTED IN CHINA

Content

1 Basic function.....	1
2 Built in Calculator.....	5
3 199SubDatum Function.....	9
4 REF Datum Memory.....	17
5 LHOLE-Tool Positioning For Line Holes.....	21
6 INCL Function.....	25
7 PCD- Tool Positioning for Pitch Circle Diameter.....	29
8 R Function.....	33
9 Simplified R Function.....	45
10 Shrinkage Calculation.....	52
11 Parameters Setup.....	59

Basic Functions

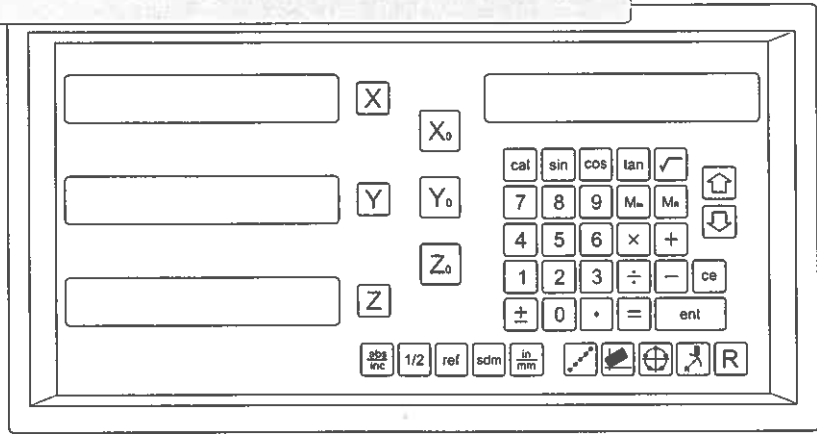

Set Display to Zero

Purpose : Set the Current position for that axis to zero

Example : To set the current **X Axis** position to zero

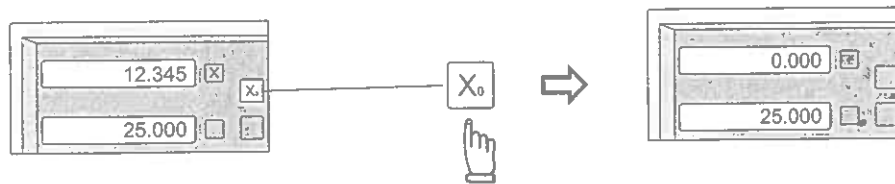

Inch/Metric Display Conversion

Purpose : Switches between inch and metric display

Example 1 : Currently in **inch** display, to switch to **metric** display

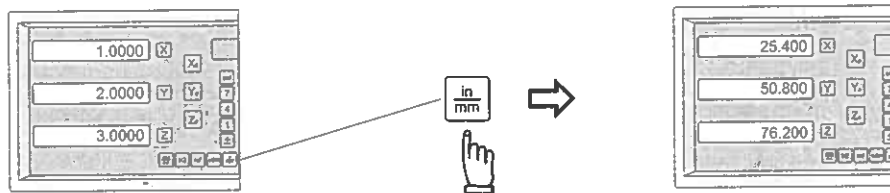

Example 2 : Currently in **metric** display, to switch to **inch** display

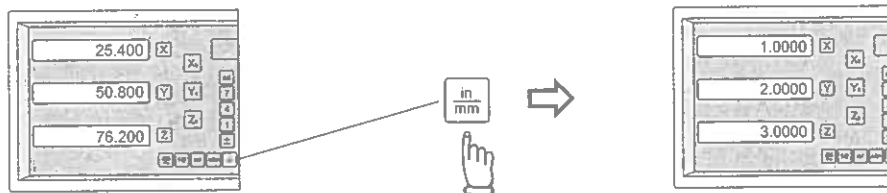

Enter Dimensions

Purpose : Set the Current position for that axis to an entered Dimension

Example : To set the current **X Axis** position to **45.800mm**

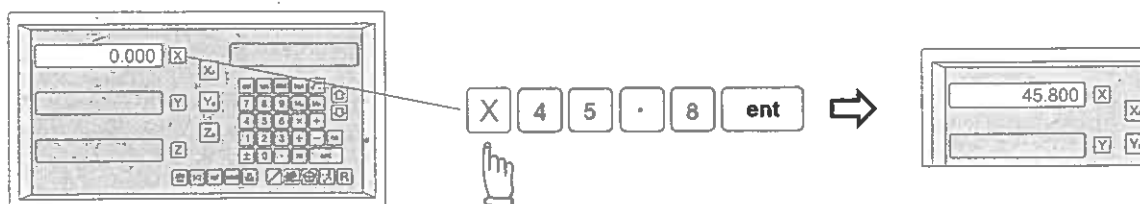

Centre Find

Purpose : Counter provide centre find function by halving the current display coordinate, so that the zero Point of the work piece is located at the centre of the work piece.

Example : To set the X Axis zero point at the centre of the work piece.

Step 1: Locate the edge finder at one end of the work piece, then zero the X Axis.

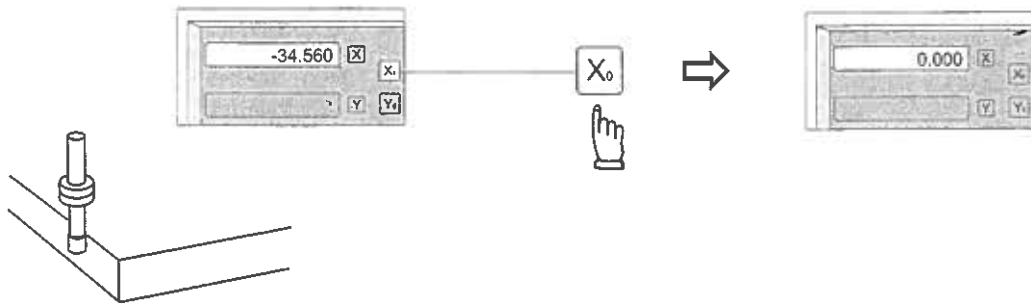

Step 2: Locate the edge finder at the opposite end of the work piece.

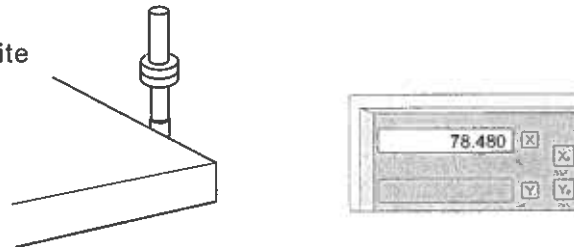

Step 3: Then half the display coordinate using centre find function as per follows

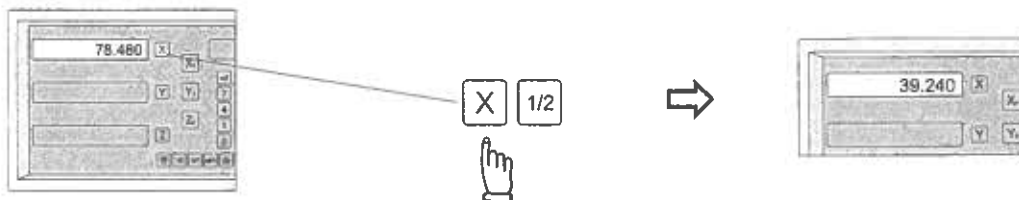

Now the X Axis zero point(0.000) is located right at the X centre of the work piece.

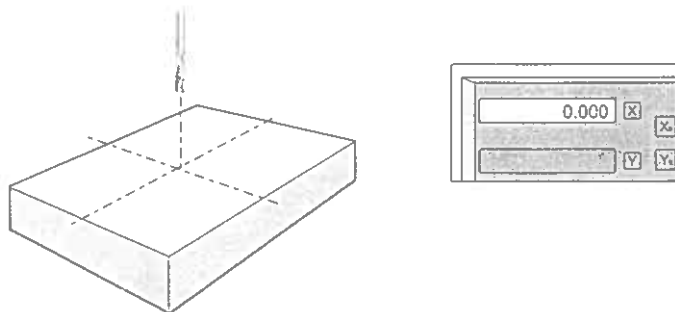

ABS/INC Coordinates display switches

Purpose : Counter provides two sets of basic coordinates display, they are **ABS** (absolute) and **INC** (incremental) displays.

During machining operations, operator can store the work piece datum (zero position) in ABS coordinate, then switch to INC coordinate to continue machining operations.

Then the operator is free to zero ing the axes or preset any dimensions into any axis in INC coordinate for any relative position machining. The work piece datum (work piece zero position) is still keep in ABS coordinate if Counter.

Operator can then switches between ABS (absolute) and INC (incremental) coordinate without losing the work piece datum(work piece zero position).

Example1 : Currently in **ABS** display coordinate, to switch to **INC** display coordinate

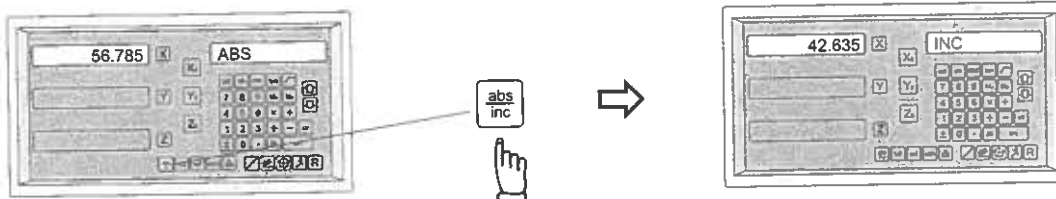

Example 2 : Currently in **INC** display coordinate, to switch to **ABS** display coordinate

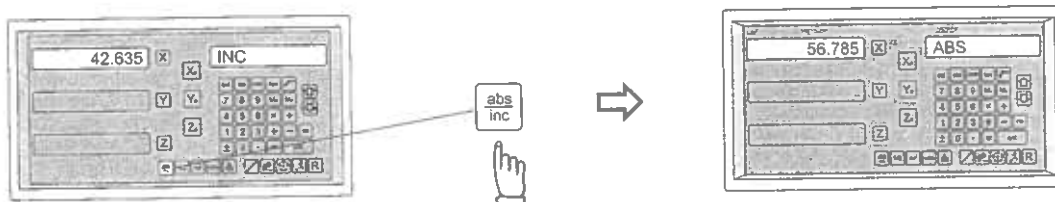

Built in Calculator

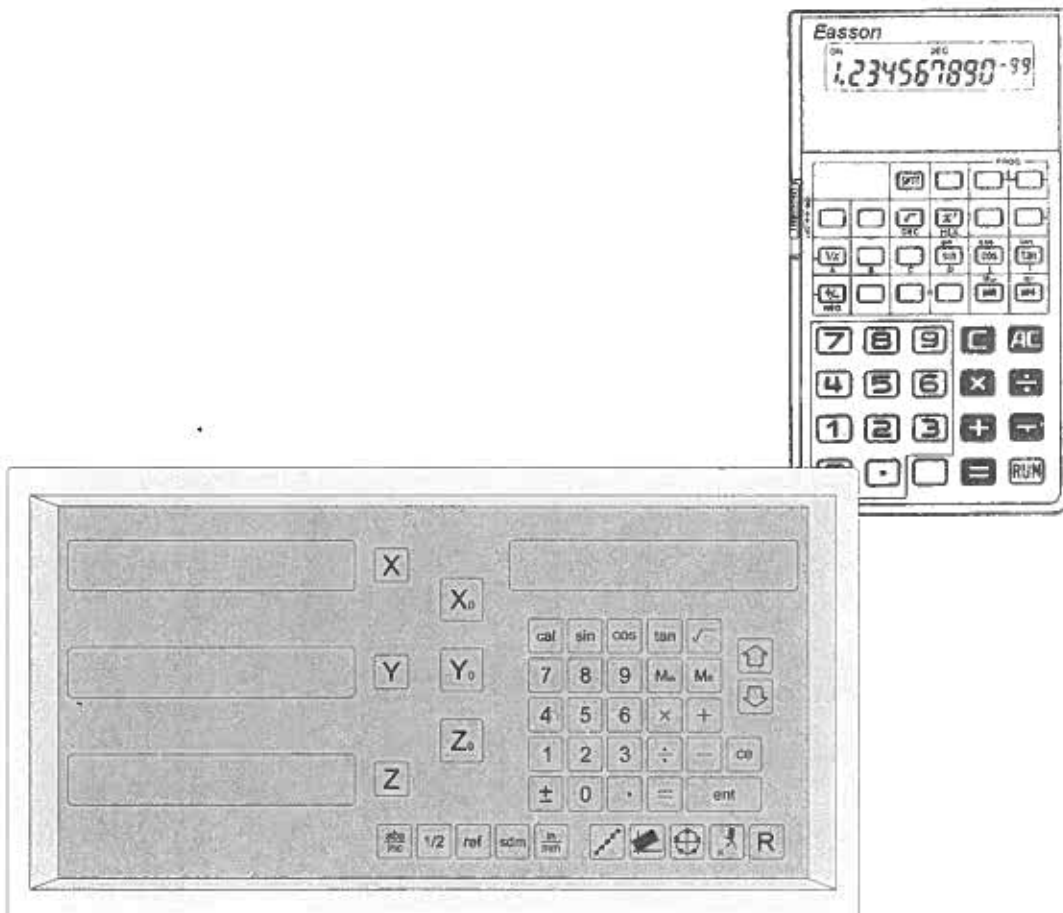

Built in Calculator

Function : A calculator is used most frequently during manual machining process..

The built in calculator of Counter not only provides normal mathematical calculations such as add, subtract, multiply, division, it also provide useful trigonometric calculations that are frequently required during machining process such as **SIN, COS, TAN, SQRT** and also inv **SIN, inv COS, inv TAN, SQUARE...**

More than that, the major feature of the built in calculator of Counter is "**Result Transfer**" all calculated result from the built in calculator of Counter can be "transferred" on any axis to posit your tool. After the result transferred on to any axis, the Counter will **temporarily** preset the zero position at the calculated value, operator simply move the machine to axis display=0.000, then the tool is posited at the coordinate of calculated result.

The built-in calculator offers following advantages:

- .Operations are same as commercially available calculators, easy to use and no need to learn
- .Calculated result can be directly transferred on to any axis, no need to mark down the Calculated result on the paper, time saving and much less mistake.
- .No unnecessary down time in finding or sharing the calculators whenever you need one to calculate.

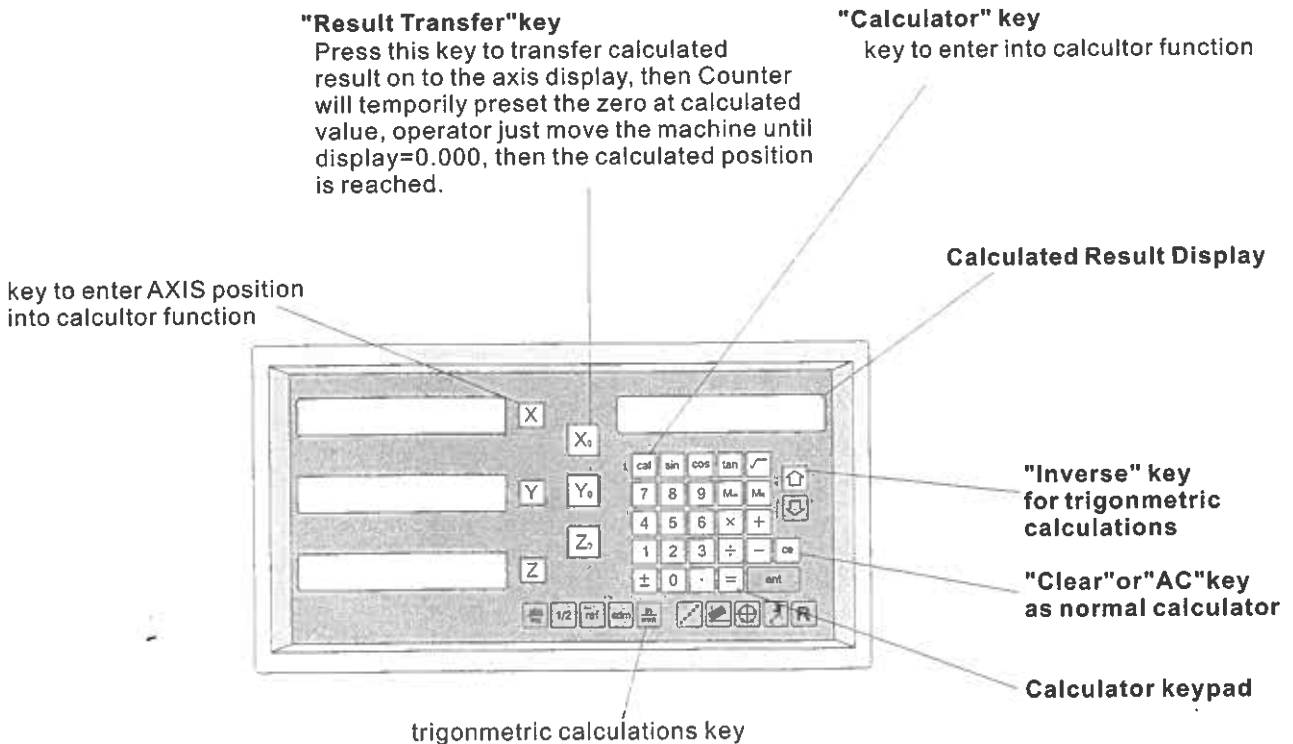

Key layout of the built in calculator

Built in Calculator

Example:

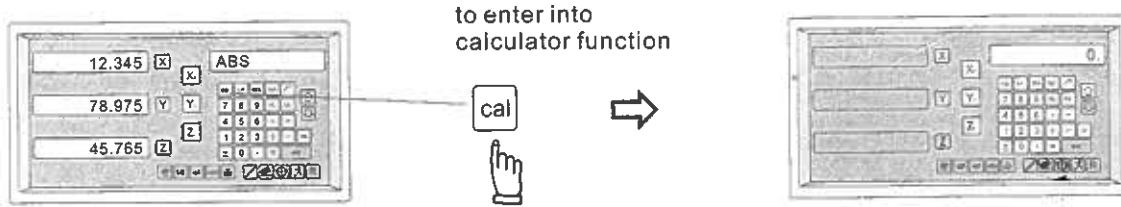

The operations of Counter built-in calculator is same as common available commercial calculator

i.e Basic mathematics -add; subtract: $78+9-11=76$

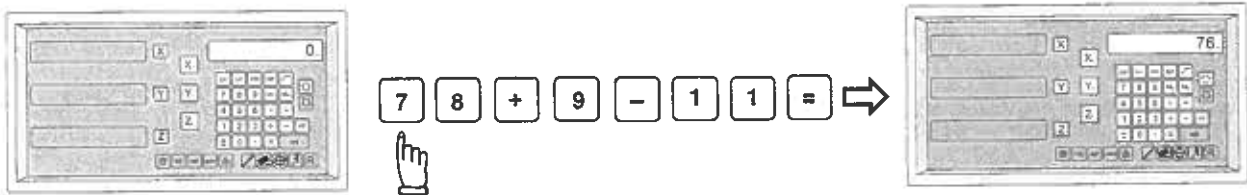

Clear-Restart the calculation

Since Counter do not have AC key-as per normal calculator, therefore, Counter use the CE key to act as the AC key as per normal calculator.

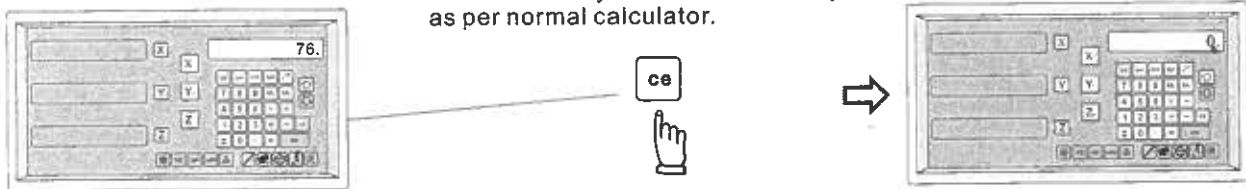

i.e Basic mathematics -multiply, division: $78 \times 9 \div 11 = 63.81818$

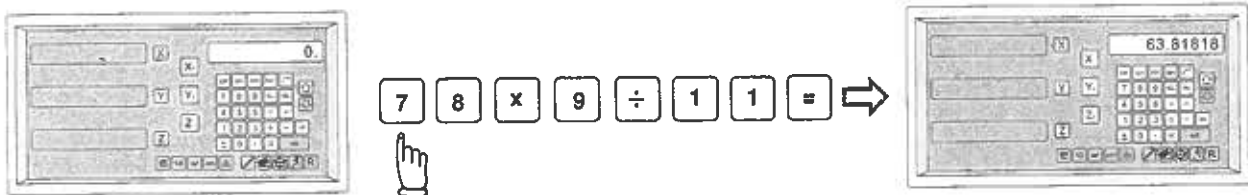

i.e Trigonometric calculation-COS: $100 \times \cos 30^\circ = 86.602540$

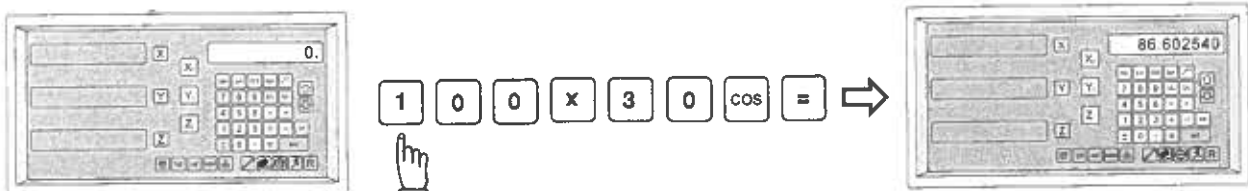

Built in Calculator

i.e Trigonometric calculation-inverse SIN: $\text{SIN}^{-1} 0.5 = 30^\circ$

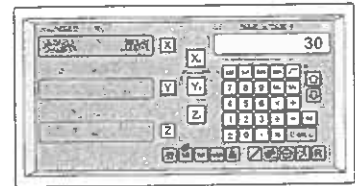
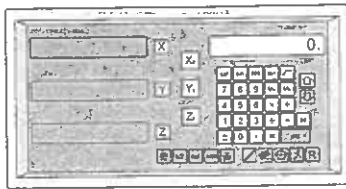

Result Transfer

i.e To move the tool at the position of X axis coordinate: $105 \times 1.035 = 108.675$

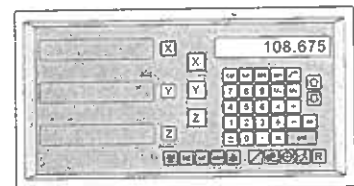

transfer the calculated result: 108.675 onto X axis for tool positioning

X axis zero position is now **temporarily** preset at X=108.675

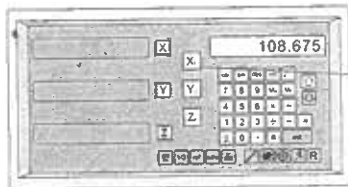

to transfer calculated result to X axis

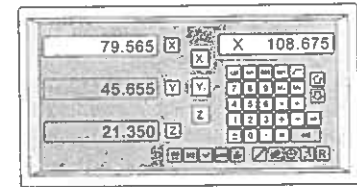

Move the machine to X display=0.000 then it is at the position of X=108.675

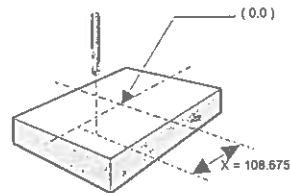
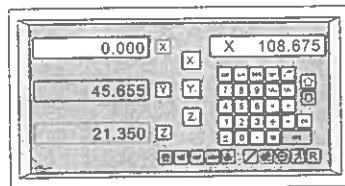

The tool now is at the position of the calculated result (X=108.675 in the above example)
To return back to normal coordinate display to continue the machining

cal OR **ce**

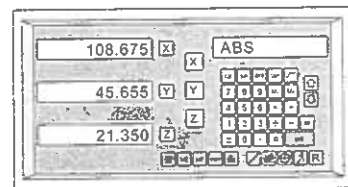
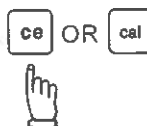
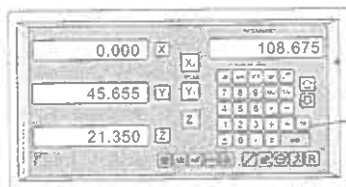

199SubDatum Function

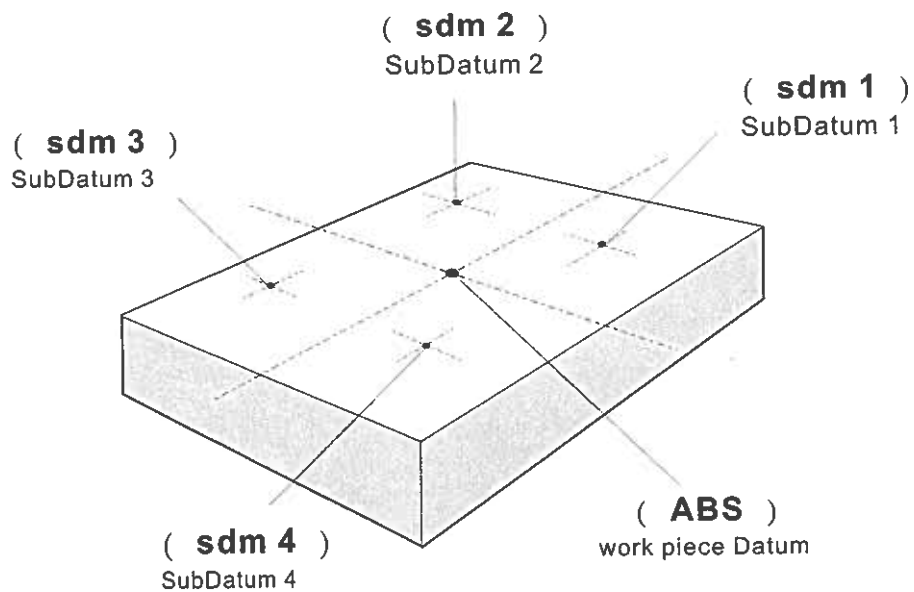

199 SubDatum Function

Purpose : Most DRO cabinet in the market just provides two set of work coordinates-ABS/INC, however, it was found that in case of a bit more complicated machining or machining a small batch of repetitive parts, just two set of work coordinate-ABS/INC is inadequate and not convenient enough to use.

ABS/INC have following shortfalls:

- In many machining, the work piece machining dimensions are come from more than two datum, therefore, operator have to switches between ABS and INC to set up the machining datums times after times. The process is time consuming and easy to make mistakes.
- In case of batch machining of repetitive work, operator have to set up and calculate all machining positions times after times.

Counter provides 199 subdatum(sdm) memory to cope with the above shortfalls of ABS/INC, however, SdM functions is not just simply provides more 199 set of INC coordinate, it is specially designed to provide much more convenience features to the operator to cope with repetitive works. Followings are the difference between INC and SdM.

1. INC is independent of ABS, it won't follow any change in ABS zero point. However, all sdm coordinate are relative to ABS coordinate, all SdM position will shift together with the ABS zero position change.
2. All SdM relative distance to ABS can be enter directly into Counter using the keypad. No need of any calculation.

sdm application in the work piece that have more than one datums.

Operator can store all the work subdatums in Counter memory as per follows.

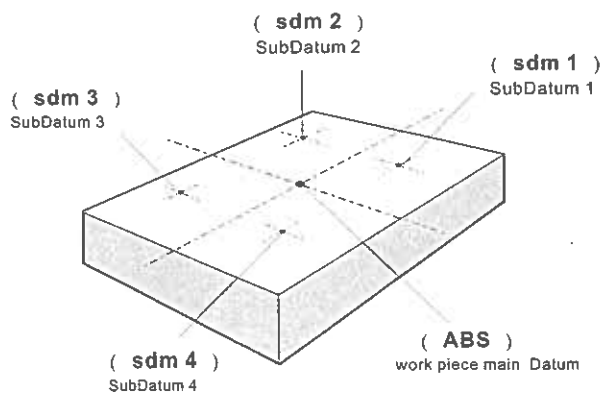

or



Operator than can switches between the subdatums directly by pressing key

No need to refer back to ABS coordinate and set up the subdatums from their relative distance from ABS

sdm application on batch machining of repetitive works

Because all sdm subdatums(0.000) are relative to ABS zero, therefore, for any repetitive works, the operator just need to set up the first work piece zero at ABS and store the machining position in subdatum zero.

For anymore repetitive parts, just set up the 2nd, 3rd.. work piece zero at ABS, then all the machining positions will reappear

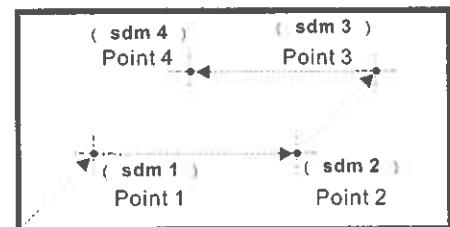

Work Piece Datum(0.000)

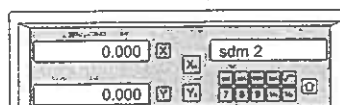

or



Press Up/Down key to go to machining points

move the machine to display=0.000, then machining location reached

Application example:

To set up the four subdatum zero(SdM1 to SdM4)as follows, followings two methods can be used

1. Move machine to required subdatum position, then zero SdM display coordinate
2. Direct key in the sdm zero position coordinate(coordinate relative to ABS zero)

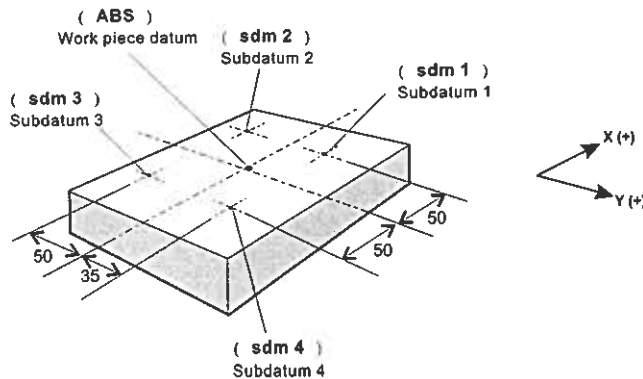

Method1: Move machine to required subdatum position, then zero SdM display coordinate

Set up the work piece datum in ABS coordinate, then move the machine to required subdatum position, then zero SdM display coordinate accordingly.

Step 1: Set up the work piece datum in ABS coordinate

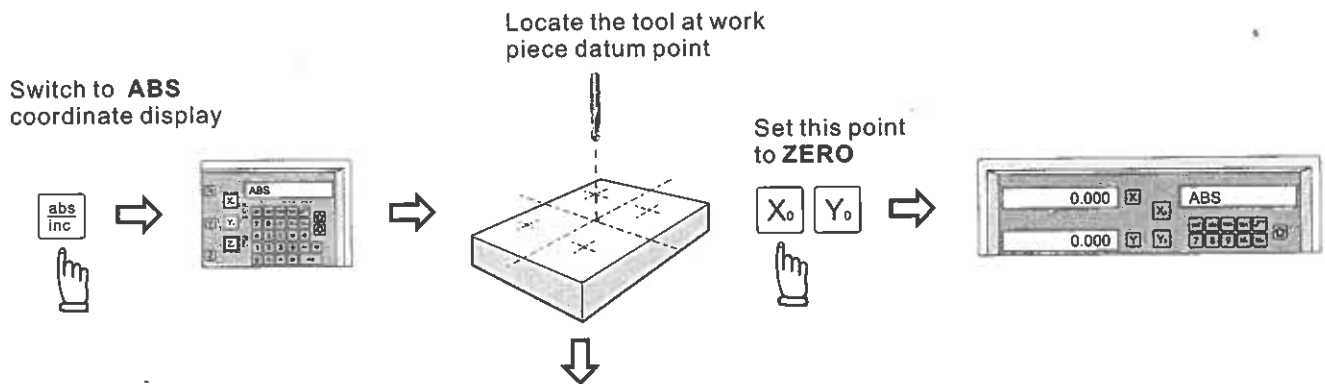

Step 2: Set up the subdatum point1(sdm1)

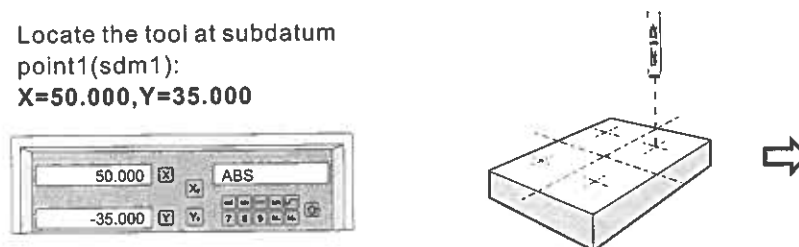

199 SubDatum Function

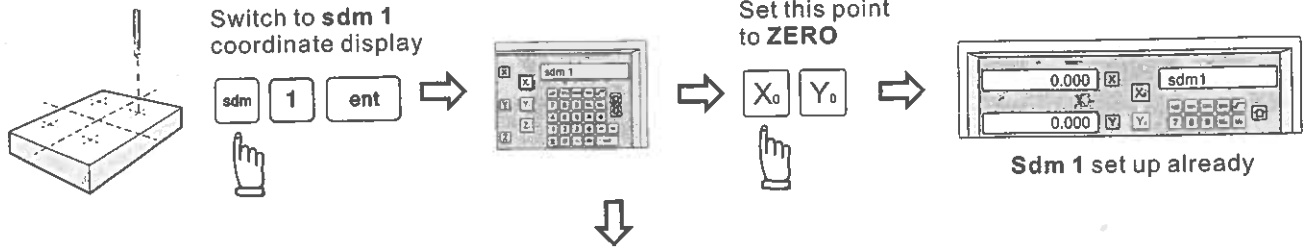

Step 3: Set up the subdatum point2(sd2)

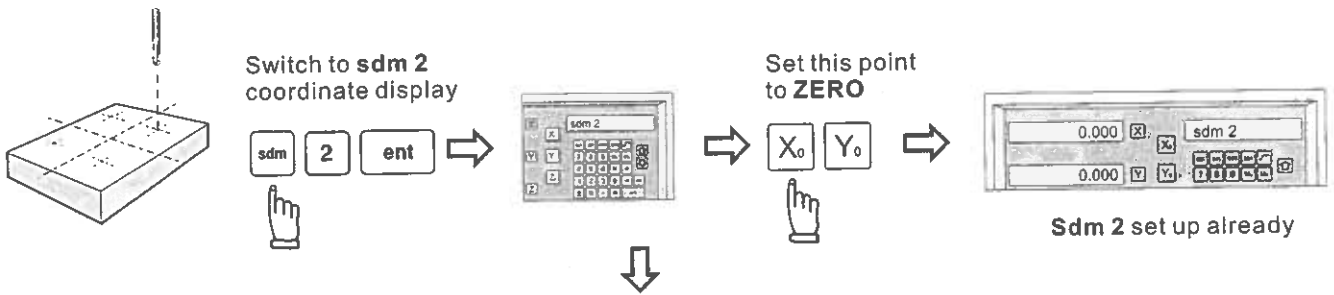
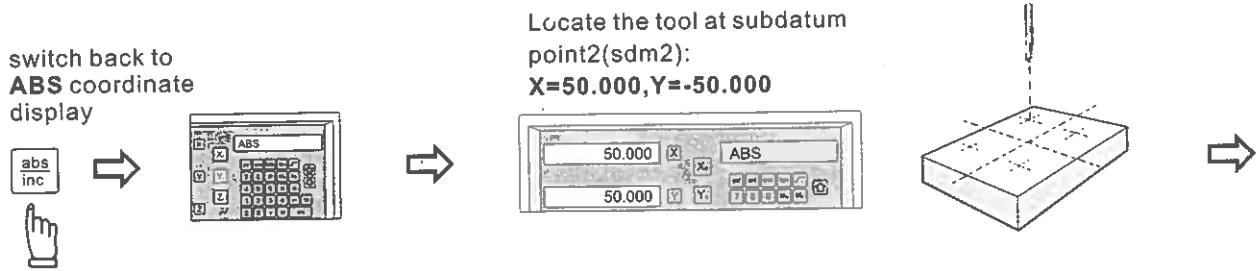

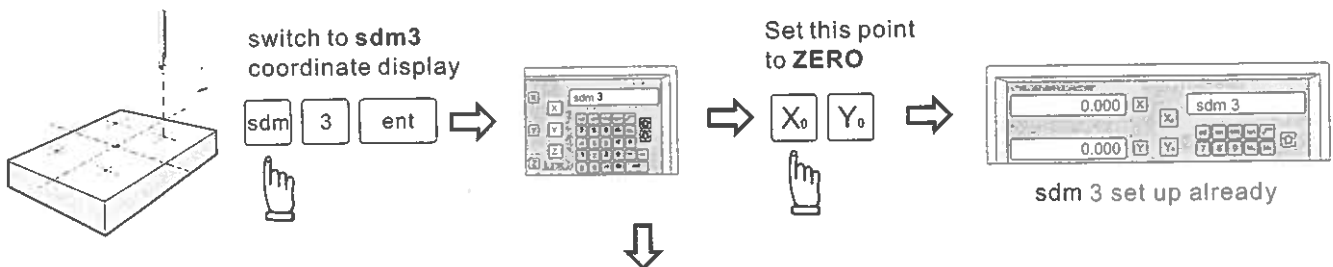
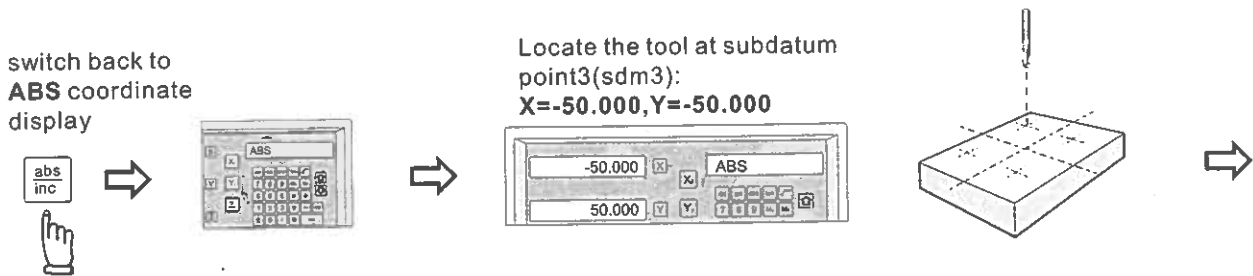

Step 4: Set up the subdatum point3(sd3)

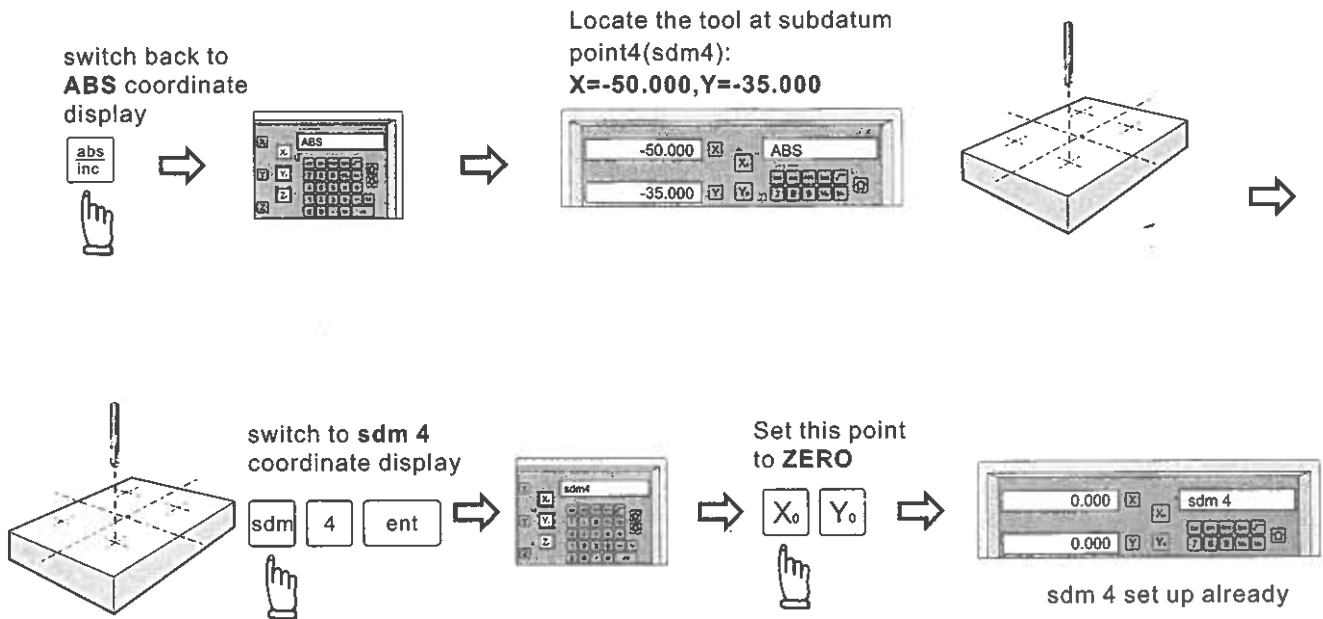

Step 5: Set up the subdatum point 4(sdm4)



All the four subdatum points have already been set up

Operator can  or  to directly switch to the required subdatum (**sdm**) coordinate

Example

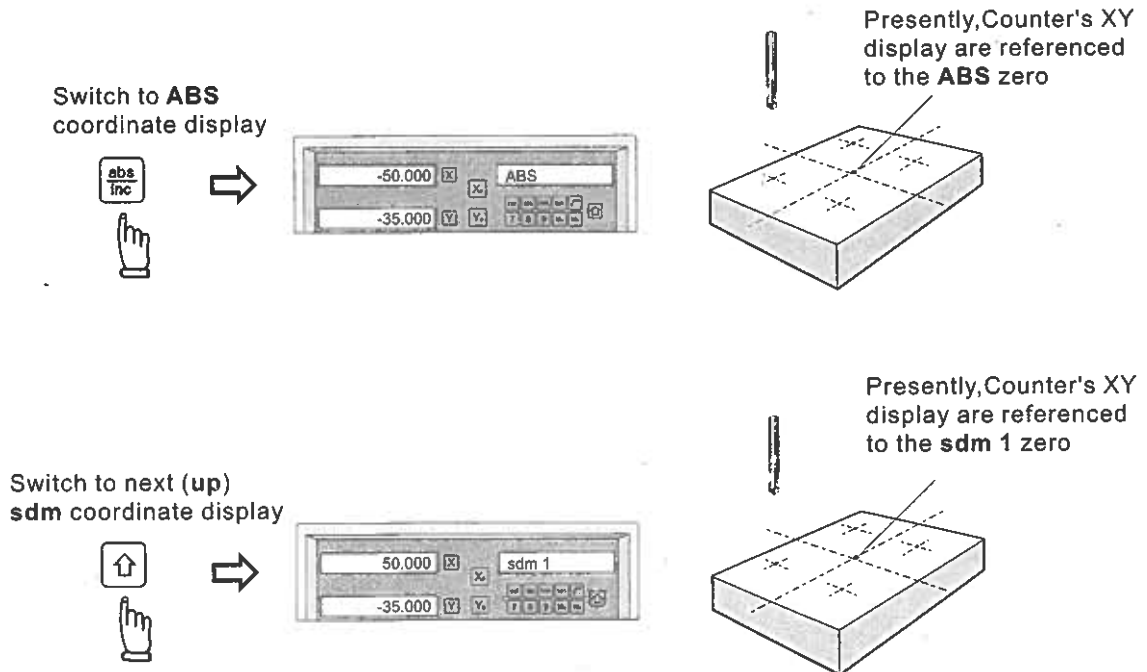

199 SubDatum Function

switch to next(up)
sdm coordinate display

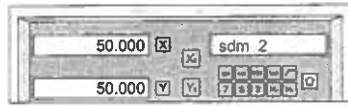

Presently, Counter's XY
display are referenced
to the **sdm 2** zero

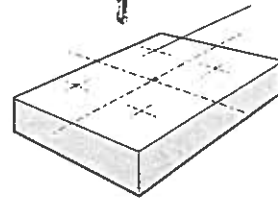

switch to previous (down)
sdm coordinate display

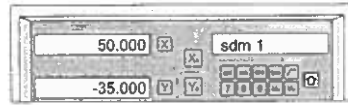

Presently, Counter's XY
display are referenced
to the **sdm 1** zero

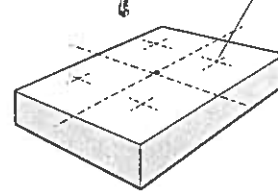

In case of many subdatum (sdm) points needed to be set up, operator will find that the method of **direct key in the sdm zero position coordinates (coordinate relative to ABS zero)** is much more quicker and less mistake.

Mthead 2 : Direct key in the sdm zero position coordinate (coordinate relative to ABS zero)

Set up the work piece datum (ZERO) at ABS coordinate, then move the tool located at work piece datum (ABS zero point), then directly key in all subdatum point coordinate (the relative position to ABS zero) using the keypad.

Step 1 : set up the work piece datum in ABS coordinate

Switch to **ABS**
coordinate display

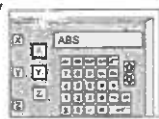

Locate the tool at work
piece datum point

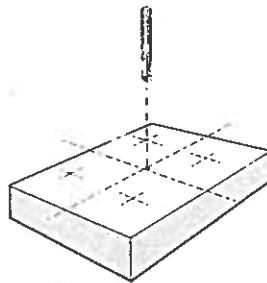

Set this point
to **ZERO**

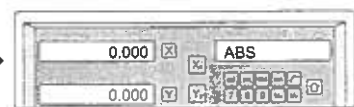

Step 2 : set up the subdatum point 1 (sdm 1)

switch to **sdm 1**
coordinate display

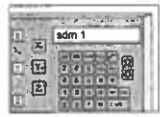
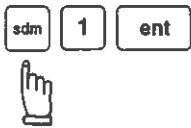

key in the **sdm 1** coordinate

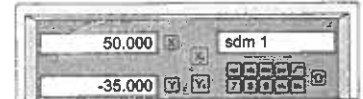

NOTICE:

when enter the **sdm** coordinate into Counter, the displayed coordinate will show **negative sign** of your entered coordinate.

It is correct because your tool is now located at zero position at ABS coordinate. If you look from the **sdm** coordinate, it is right at the negative value of the **sdm** zero position coordinate.

Step 3 : set up the subdatum point 2 (sdm2)

switch to **sdm 2**
coordinate display

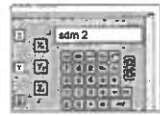
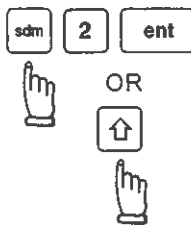

key in the **sdm 2** coordinate

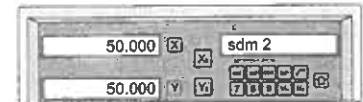

Step 4 : set up the subdatum point 3 (sdm 3)

switch to **sdm 3**
coordinate display

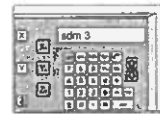
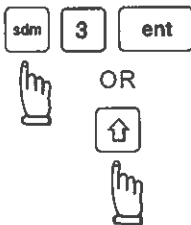

key in the **sdm 3** coordinate



Step 5 : set up the subdatum point 4 (sdm 4)

switch to **sdm 4**
coordinate display

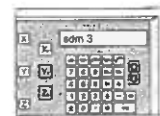
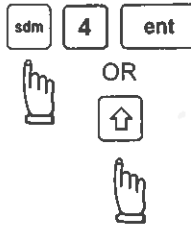

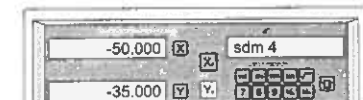

key in the **sdm 4** coordinate



199 SubDatum Function

All the four subdatum points have already been set up

Operator can  or  to directly switch to the required subdatum (sdm) coordinate

Example

Switch to ABS coordinate display

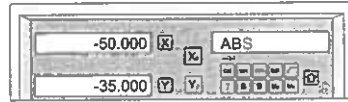
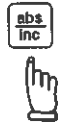

Presently, Counter's XY display are referenced to the ABS zero

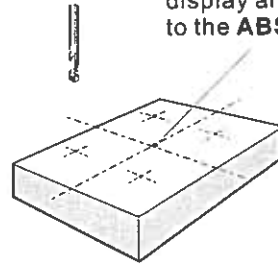

Switch to next(up) sdm coordinate display

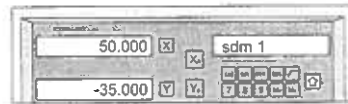

Presently, Counter's XY display are referenced to the sdm 1 zero

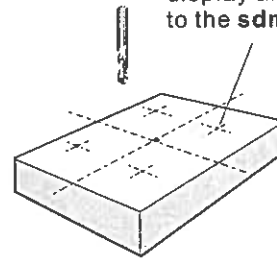

Switch to next(up) sdm coordinate display

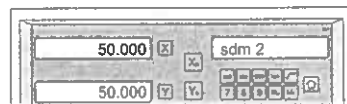

Presently, Counter's XY display are referenced to the sdm 2 zero

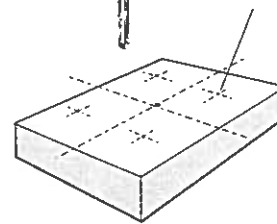

Switch to previous(down) sdm coordinate display

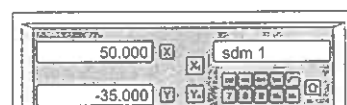

Presently, Counter's XY display are referenced to the sdm 1 zero

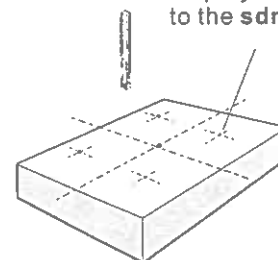

ref datum memory

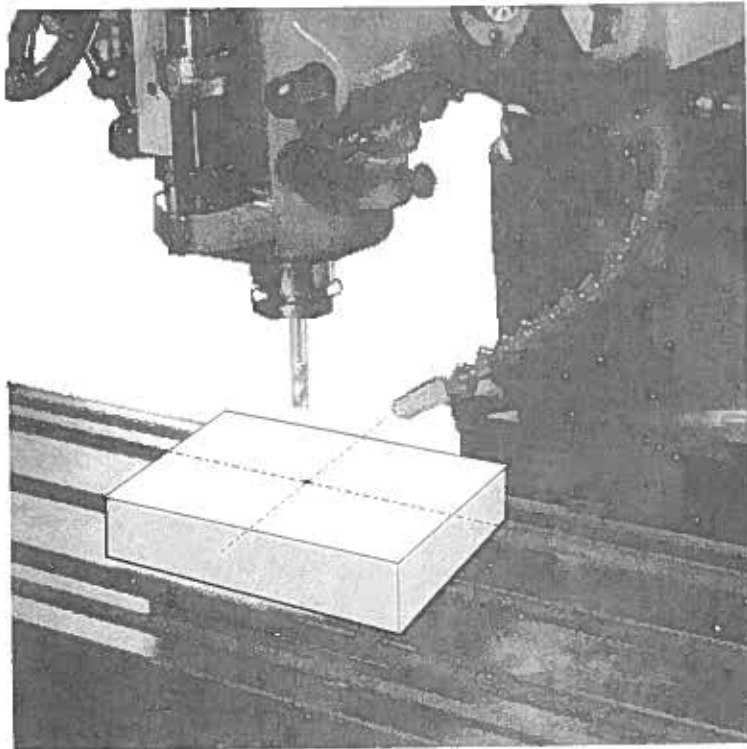

ref datum memory function

Function : During the daily machining process, it is very common that the machining cannot be completed within one work shift, and hence the DRO have to be switched off after work, or power failure happen during the machining process which is leading to lost of the work piece datum (work piece zero position), the re-establishment of work piece datum using edge finder or other method is inevitably induce higher machining inaccuracy because it is not possible to re-establish the work piece datum exactly at the previous position.

To allow the recovery of work piece datum very accurately and no need to re-establish the work piece datum using edge finder or other methods, every glass grating scale have a ref point location which is equipped with ref position to provide datum point memory function.

The working principal of the ref datum memory function are as follows.

-There are a permanent and fixed mark (position) in the center of every glass grating scale, normally called *ref* mark or *ref* point..

Since this *ref* point position is permanent and fixed, it will never change or disappear when the DRO system is switched off. Therefore, we simply need to store the distance between the *ref* point and the work piece datum (zero Position) in DRO's memory. Then in case of the power failure or Counter being switched off, we can recover the work piece datum (zero position) by presetting the display zero position as the stored distance from the *ref* point.

Example : to store the X axis work datum

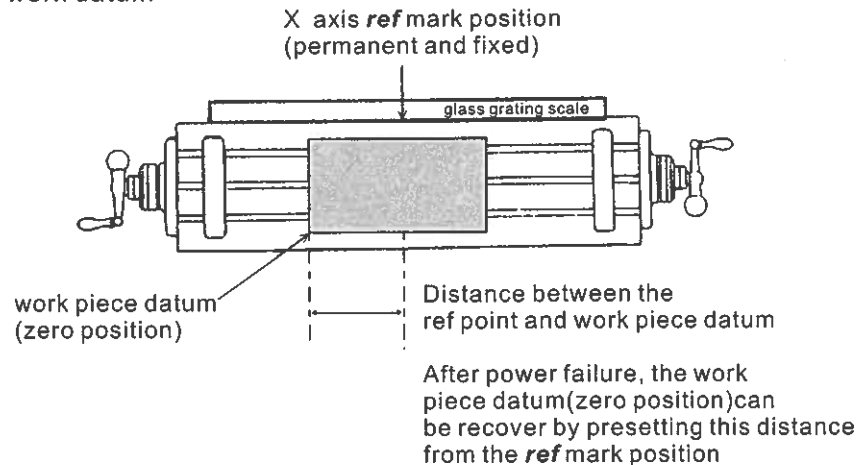

Operation : Counter provides one of the most easy to used *ref* datum memory function

There is no need to store the relative distance between the *ref* mark and your work datum zero into Counter, when ever you alter the zero position of **ABS** coordinate, such as by zeroing, center find, coordinate preset or etc..., Counter will automatically store the relative distance between **ABS** zero and the *ref* mark location into Counter's memory.

In daily operation, operator simply need to find the *ref* mark position whenever they switch on the Counter to let Counter know where the *ref* mark position is, then Counter will automatically do the work datum storage on its 'own whenever you alter the **ABS** zero position. In case power failure or the Counter switched off, the operator can recover the work piece datum easily by the **RECALL 0** procedure.

find the scale's *ref* mark position (**FIND REF**)

Function : Because in **Counter's ref** datum memory function, **Counter** will automatically store the relative distance between the *ref* mark position and the work piece datum (zero position) whenever the operator alter the **ABS** zero position ,such as zeroing, center find, coordinate preset or etc...

Therefore, **Counter** need to know where the *ref* mark position in prior to machining operation. In order to avoid the lost of work piece datum (zero Position) during any accidental or unexpected events, such as power failure or etc.. It is highly recommend that operator find the *ref* mark position using the (**FIND REF**)function whenever they switch on the **Counter**

Step 1 : enter into the ref function, select the **FUND REF** (find *ref* mark)

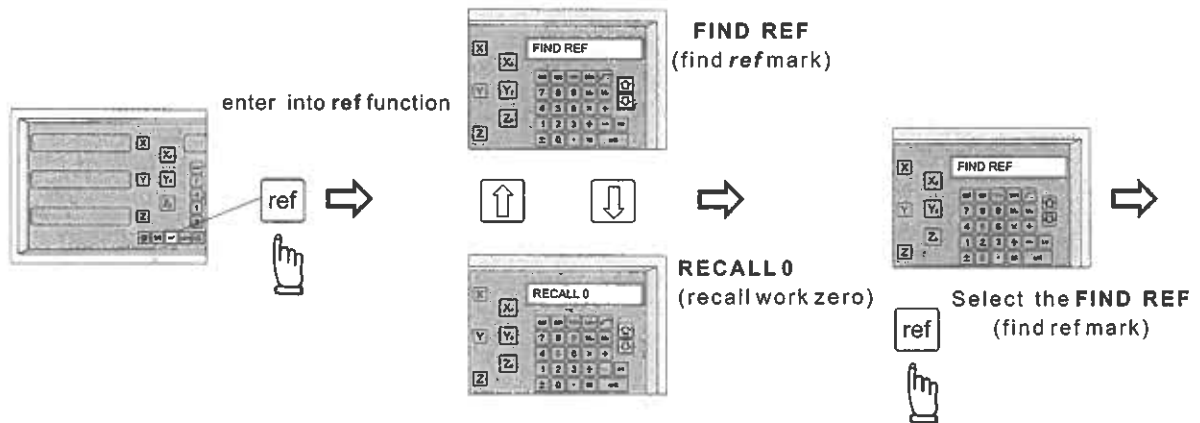

Step 2 : select the axis of which *ref* mark needed to be found

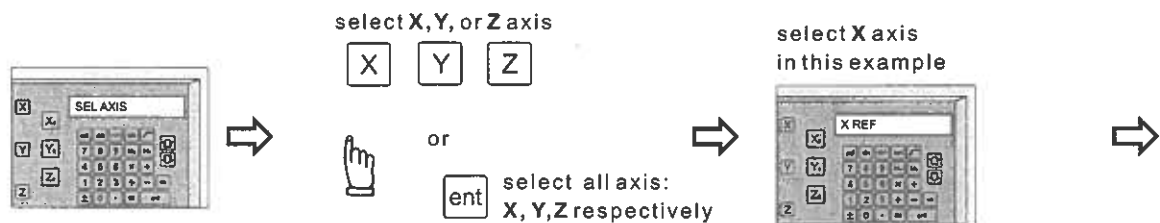

Step 3 : move the machine across the center of the glass grating scale until digits display in counter start run.

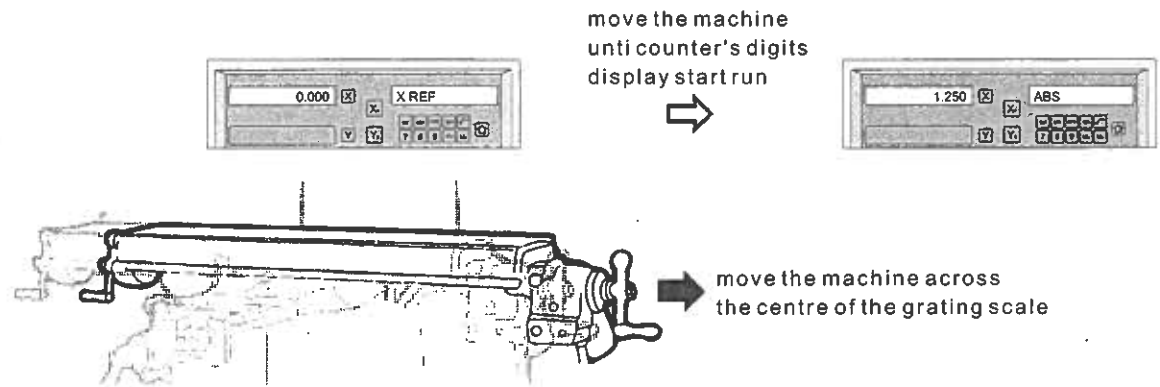

recall the work datum zero (RECALL 0)

Function: after lost of the work piece datum due to power failure or switch off of counter, the work piece datum can be recover by **RECALL 0** function as per following procedures.

Step 1: enter into the *ref* function, select the **RECALL 0**(recall work piece zero)

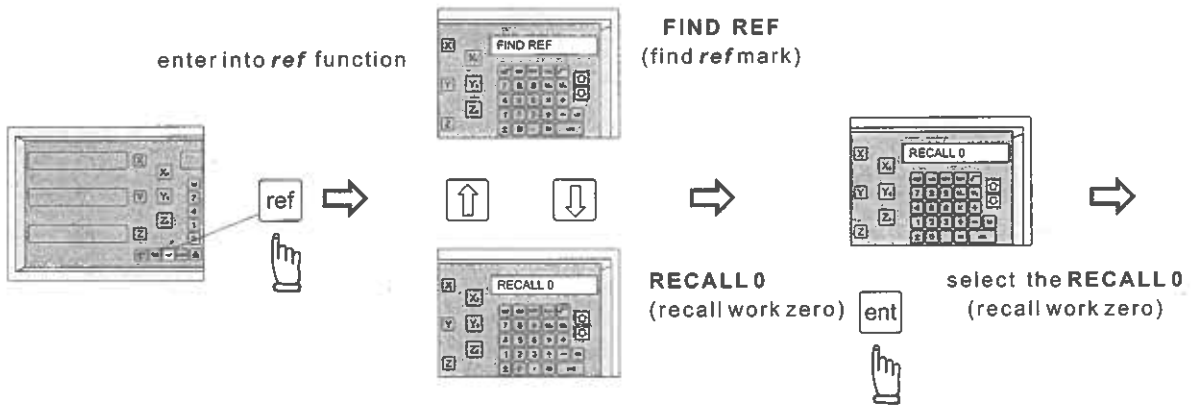

Step 2: Select the axis of which work datum (zero position) needed to be recovered

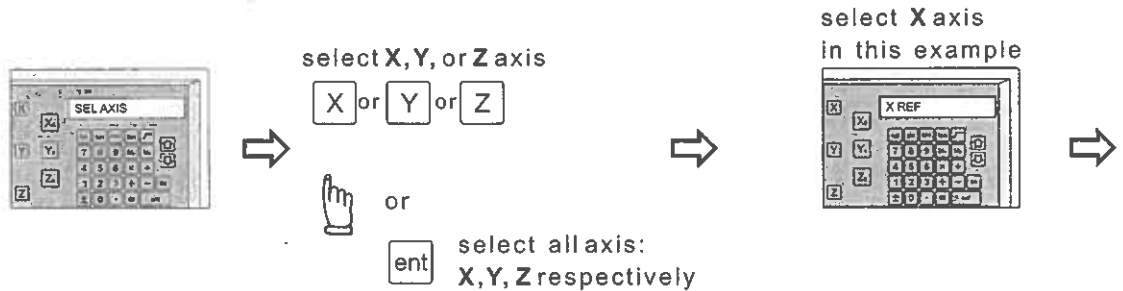

Step 3: move the machine across the center of the glass grating scale until digits display in Counter start run, then the work piece datum is recovered

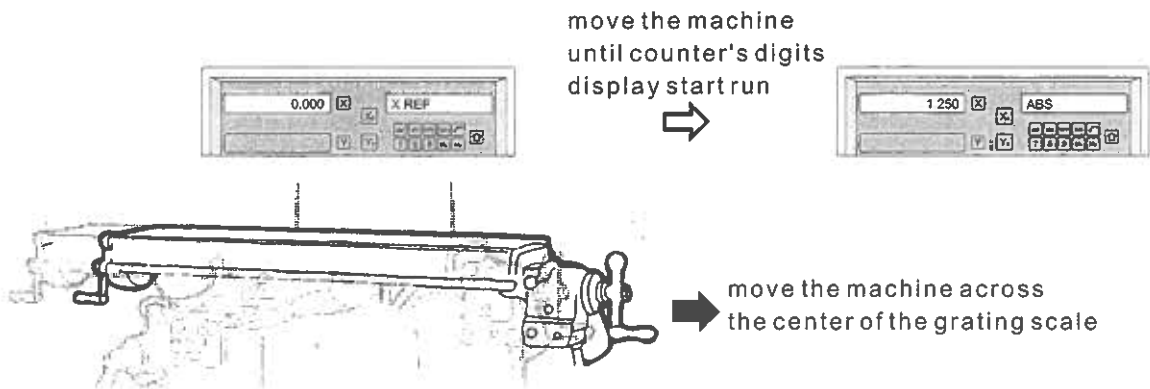

LHOLE -Tool positioning for Line Holes

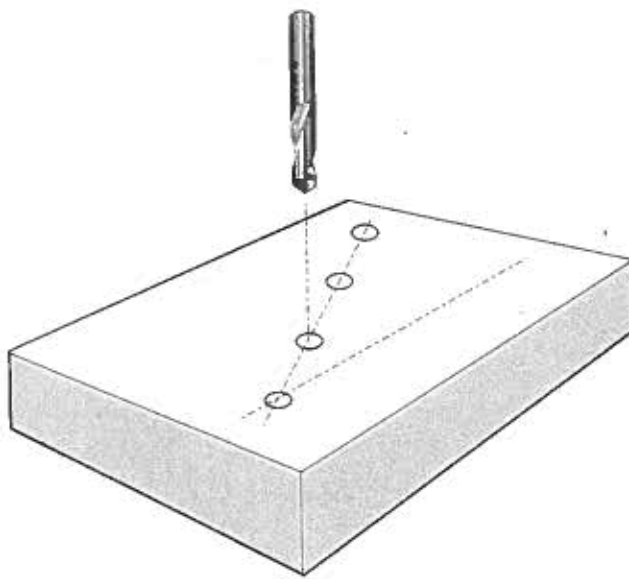

LHOLE - Tool positioning for Line Holes

Function: Counter provides LH OLE function to for the hole drilling along a Line. Operator simply enter following machining parameters as per the step by step guides that indicated on the Counter's message display, then the Counter will calculate all the holes position coordinate and temporarily preset those holes position coordinates to zero(0.000),operator move the machine until the display axes=0.000,then the Line Holes position is reached.

- Line Angle (LIN ANG)
- Line Distance (LIN DIST)
- No. Of Holes (No.HOLE)

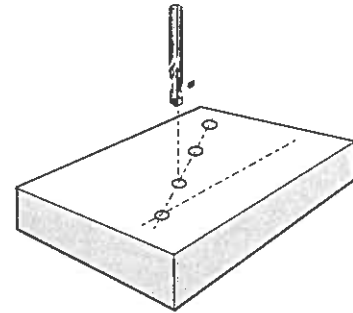

After the above machining parameters entered into Counter, Counter preset all the Line Hole positions to 0.000

Operator can press or to select the Line Hole, and then move the machine to display =0.000 , then the Line Hole position is reached

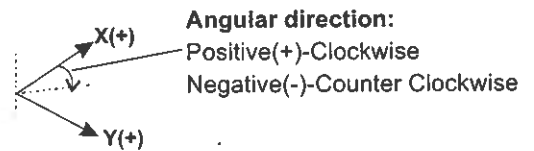

Example

Line Angle (LIN ANG).....-30 degree (Counter Clockwise)
Line Distance (LIN DIST).....80.000mm
No.of Holes (No.HOLE).....4

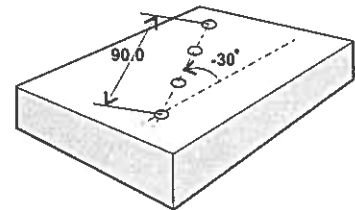

Step 1: Since the LHOLE function start use the current to enter the LHOLE function tool position as the starting point, therefore, locate the tool at the **First LINE HOLE** position

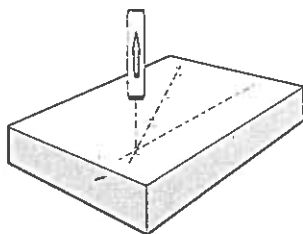

locate the tool at the first Line Hole position

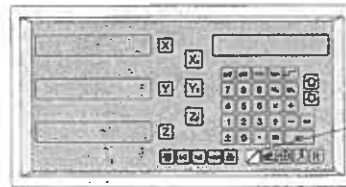

to enter the LHOLE function

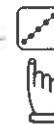

enter the Line Angle (LIN ANG)

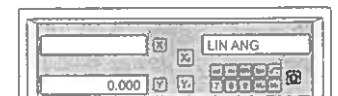

LHOLE -Tool positioning for Line Holes

Step 2: Enter Line Angle (LIN ANG)

Line Angle (LIN ANG)=-30 degree

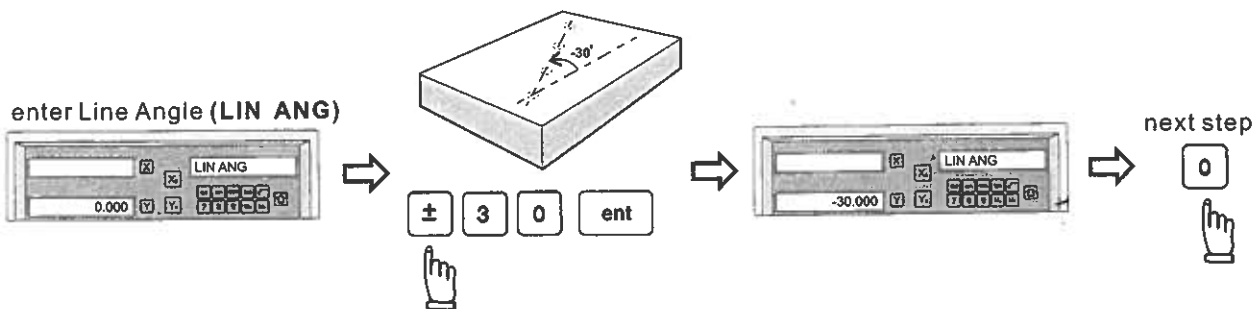

Step 3: Enter Line distance(LIN DIST)

Line distance Angle(LIN DIST)=80.00

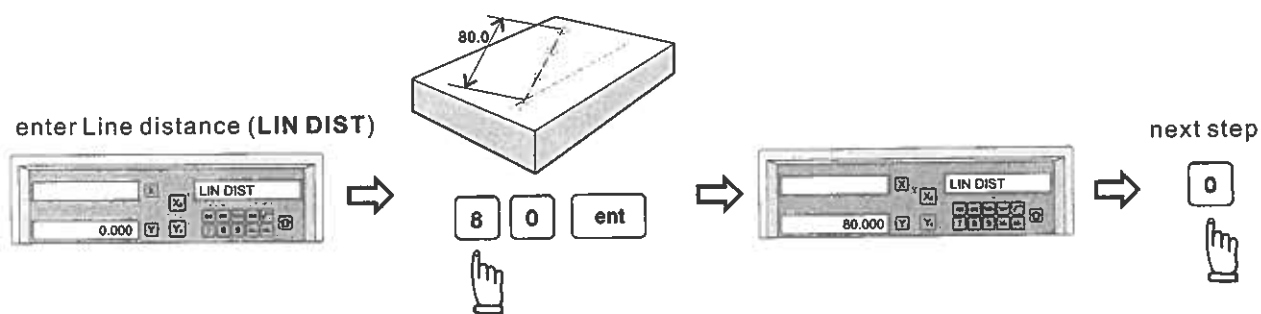

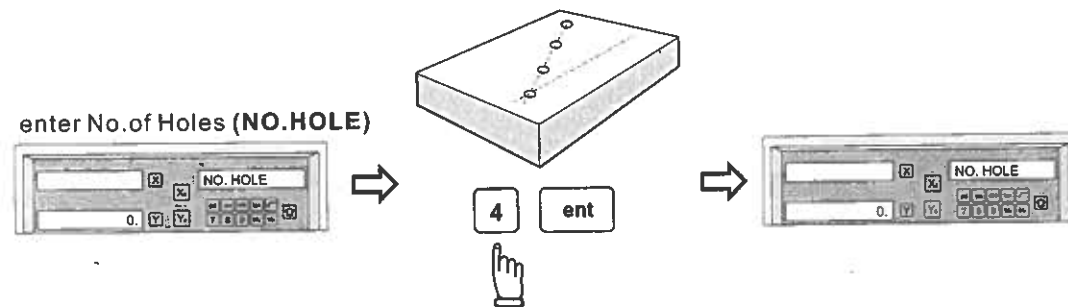

Step 4: Enter No.of Holes (NO.HOLE)

No.of Holes (NO.HOLE)=4



All LHOLE machining parameters  to enter into LHOLE drilling mode already entered into Counter

Operator can  or  to select the Line Hole, then move the machine to display=0.000, then the Line Hole position is reached.

LHOLE -Tool positioning for Line Holes

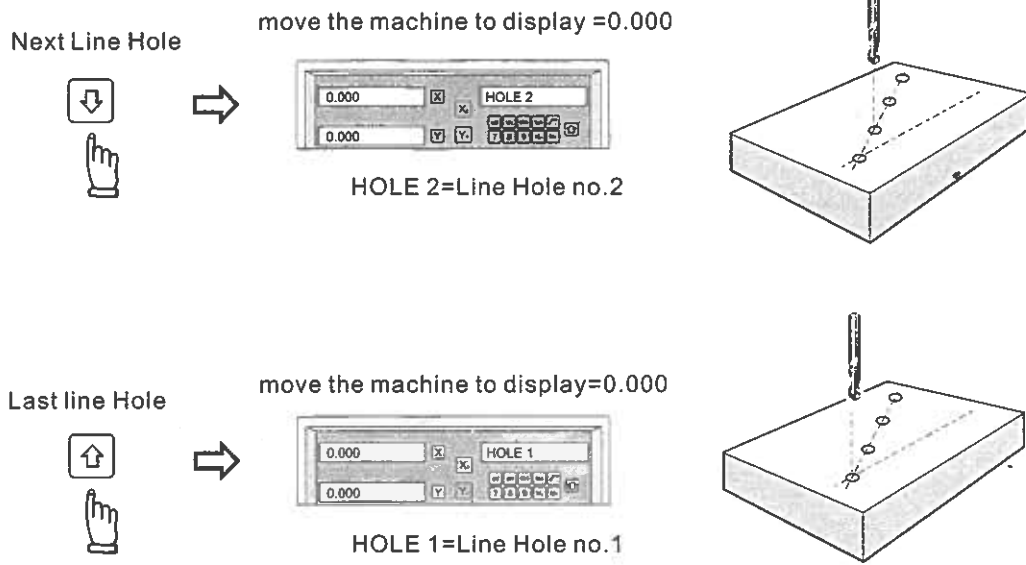

Anytime the operator want to check or verify if Counter's LHOLE calculation correct or not, or want to temporarily exit the LHOLE function cycle (swap to normal XYZ display). Operation are as follows:.

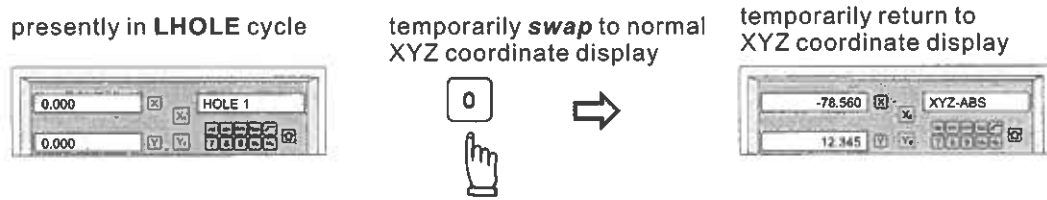

Swap back to LHOLE cycle to continue the Line Holes drilling operation

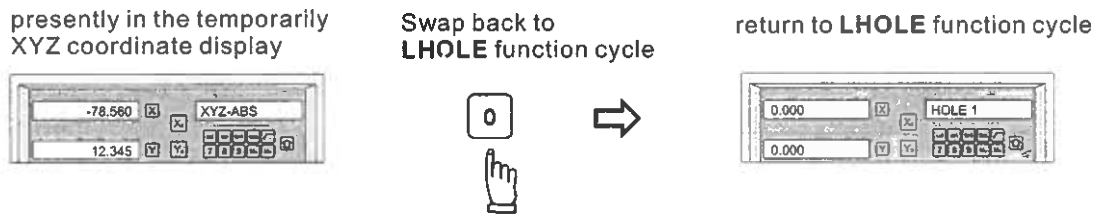

After the Line Holes drilling operation completed, to quit from the LHOLE function cycle, procedure are as follows



INCL - Inclined surface datum tool positioning

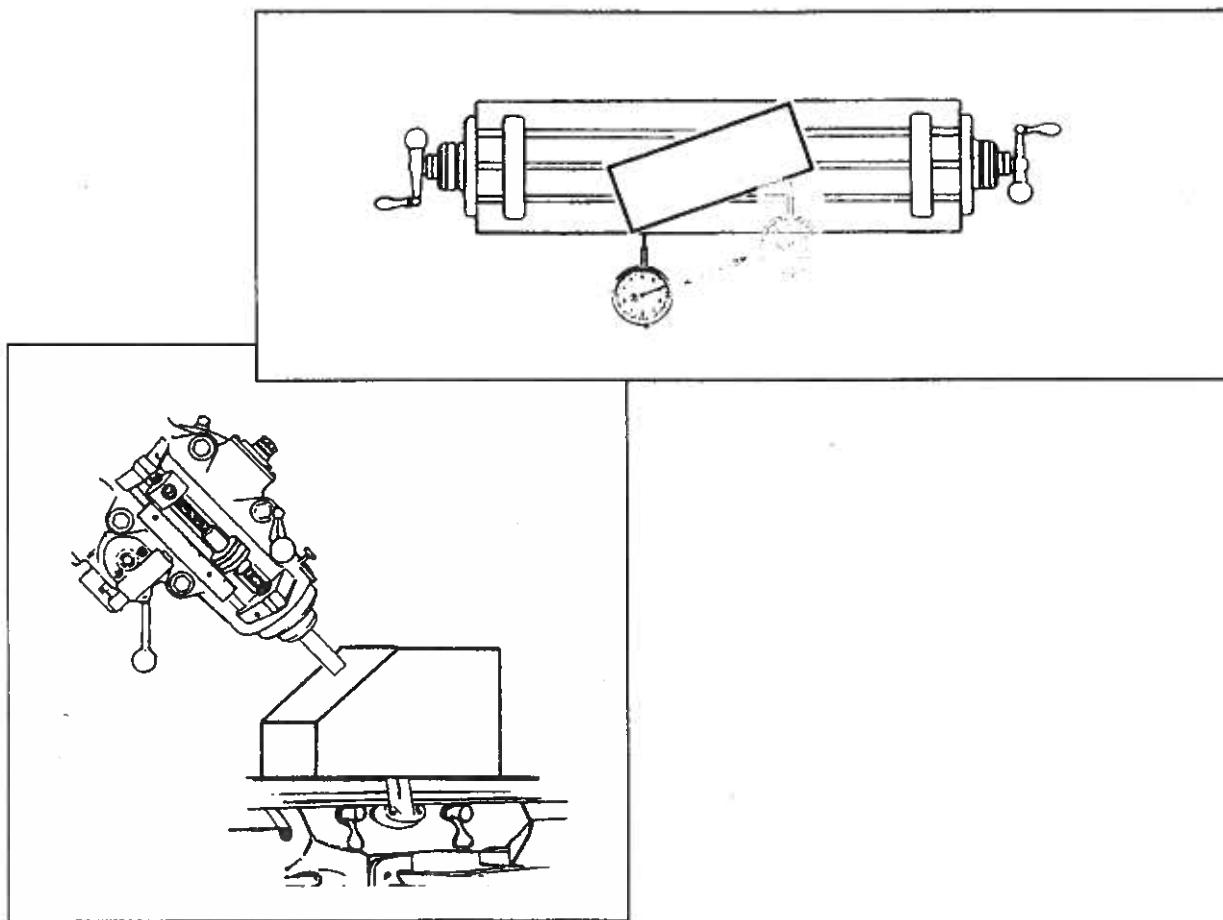

INCL -Inclined surface datum tool positioning

Function: During daily machining process, it is quite common to machine an inclined surface.

If the work piece is small or the accuracy requirement is quite low, operator can simply work on an incline table or rotary table to machine the inclined work or surface very easily.

However, when the **work piece too big** to be installed onto the an incline table or the **accuracy requirement is high**. The only solution is to calculate the machining points or datuming points using mathematical method. But it is time consuming.

Counter provide easy to use **INCL** to help the operator for precision inclined surface datuming and machining.

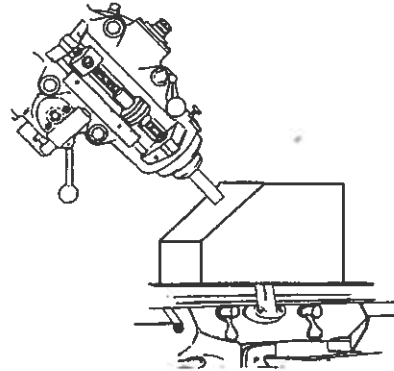

Application of the INCL function are as follows:

A) **XY plane** -to accurately datum the work piece at an inclined angle

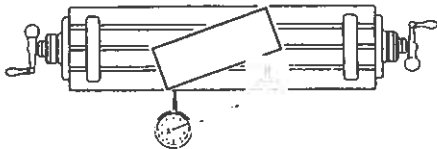

B) **XY /YZ plane**-Machine an inclined surface

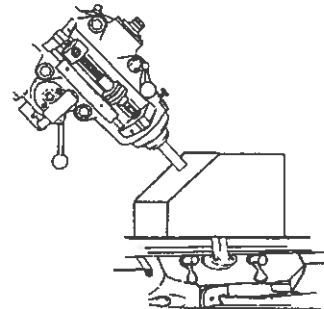

Example :

To accurately datum the work piece at 20 degree on XY plane

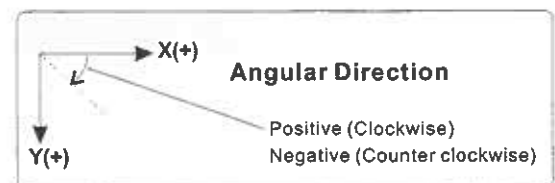

Operation procedure

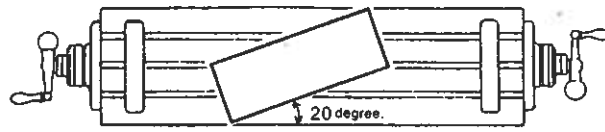

Install the work piece onto an rotary table at approximately 20 degree.

Step 1: select XY plane as the work plane (INCL-XY)

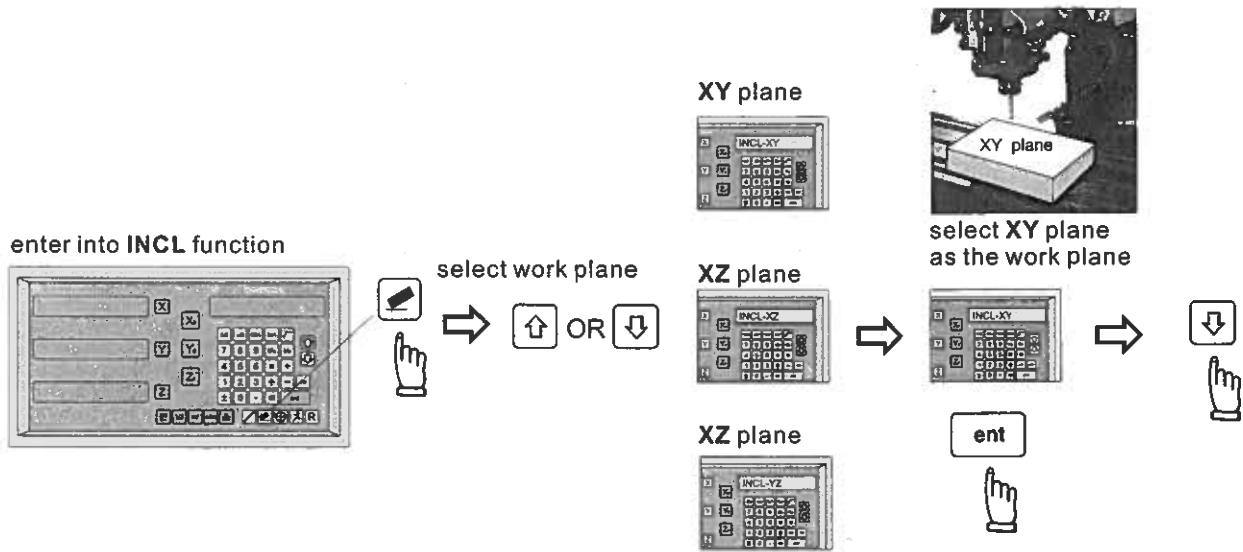

Step 2: enter incline angle (INCL ANG)

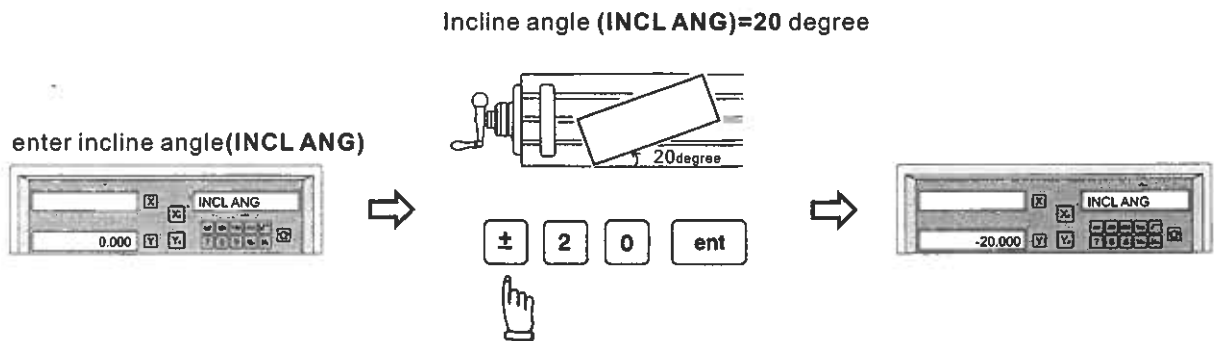

All INCL machining parameters  to enter into INCL datuming mode already entered into Counter 

NCL - Inclined surface datum tool positioning

A) zero the dial indicator on one end of the work piece

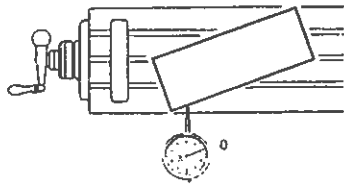

zero the ES-1

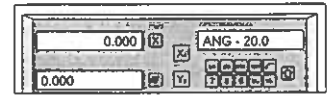
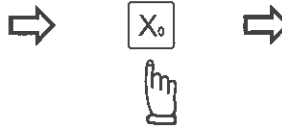

Since in INCL mode, the Y display is set according to $X \cdot \tan(\text{ANG})$, therefore, zeroing the X axis also clear the Y axis.

B) After move the machine to Y axis display=0.000, then the Y axis position is accurately positioned at 20 degree, operator can fine tune the work piece incline angle until the dial indicator at zero

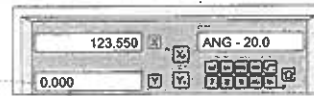
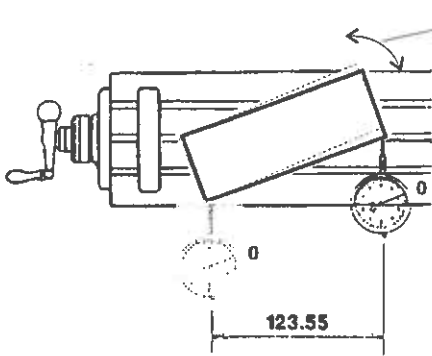

Y axis zero position will follow the X axis position at the angle of ANG (-20 degree in this example) operator just move the Y axis to display = 0.000 it is then at highly accurate 20 degree position.

Since during the incline angle alignment, angular adjustment of any one end of the work piece will affect the the position on the other end. Therefore, the above angular alignment procedure A)&B) have to be carried out iteratively until operator satisfy with the angular alignment achieved.

Anytime the operator want to check or verify if Counter's INCL calcaution correct or not, or want to temporarily exit the INCL function cycle (swap to normal XYZ display).Operation are as follows:.

presently in INCL cycle



temporarily **swap** to normal XYZ coordinate display

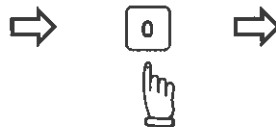

temporarily return to XYZ coordinate display



swap back to INCL cycle to continue the INCL incline angle alignment

presently in the temporarily XYZ coordinate display



swap back to INCL function cycle

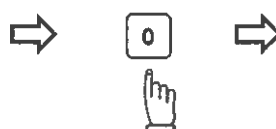

presently in INCL cycle

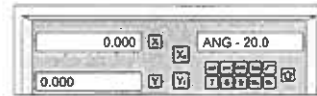

PCD -Tool positioning for Pitch Circle Diameter

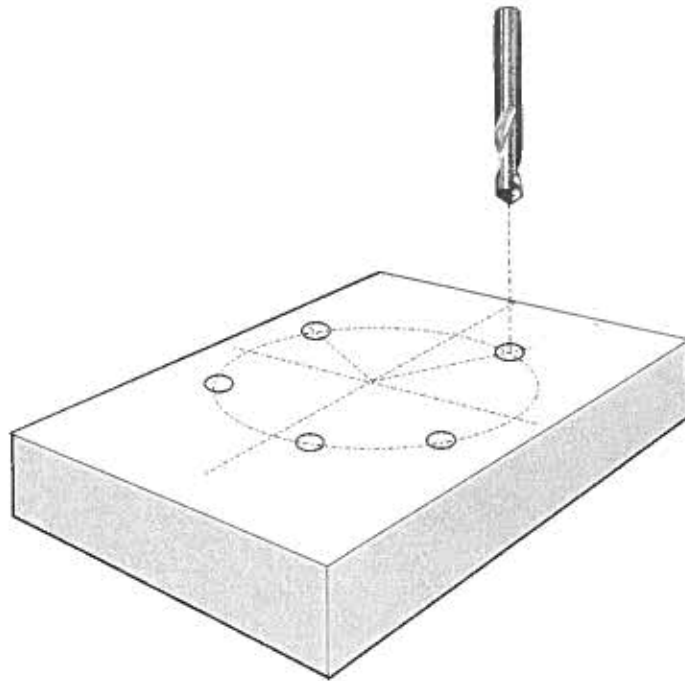



PCD -Tool positioning for Pitch Circle Diameter

Function: Counter provides PCD function to for the hole drilling along the Pitch Circle Diameter. Operator simply enter following machining parameters as per the step by step guides that indicated on the Counter's message display, then the Counter will calculate all the pitch holes position coordinate and temporarily preset those holes position coordinates to zero (0.000),operator move the machine until the display axes=0.000,then the pitch holes position is reached.

- Centre (**CENTRE**)
- Diameter (**DIA**)
- No.of Holes(**NO.HOLE**)
- Start Angle(**ST.ANG**)
- End Angle (**END.ANG**)

After the above machining parameters entered into Counter, Counter preset all the pitch hole positions to 0.000

Operator can press  or  to select the pitch hole, and then move the machine to display=0.000, then the pitch hole position is reached

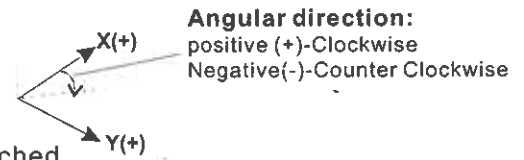
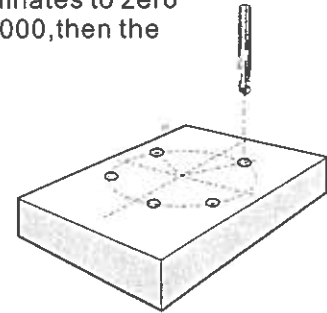

Example

- Centre Coordinate (**CENTRE**).....X=0.000,Y=0.000
- Diameter (**DIA**).....80.000mm
- No.of Holes(**NO.HOLE**).....5holes
- Start Angle(**ST.ANG**).....30 degree(clockwise)
- End Angle(**END.ANG**).....300 degree(clockwise)

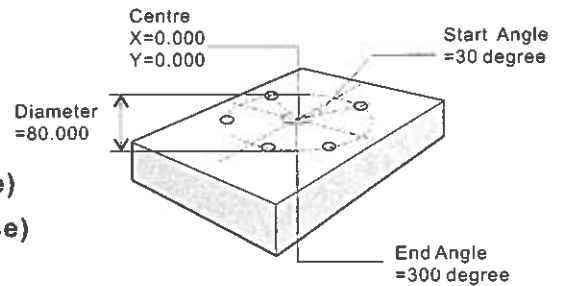

step1: Setup the work piece datum(work piece zero)  to enter the **PCD** function

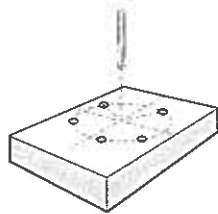

set up work piece datum



to enter the **PCD** function

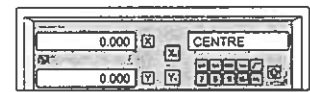

enter the **CENTRE** coordinate

Step2: Enter Centre Coordinate (**CENTRE**)

Centre Coordinate (**CENTRE**):X=0.000,Y=0.000

enter centre coordinate(**CENTRE**)

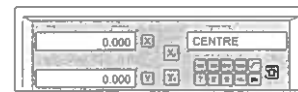
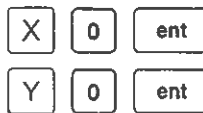
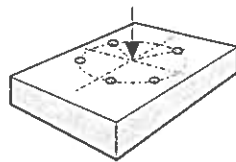
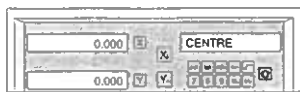

next step



Step 3: Enter Diameter (DIA)

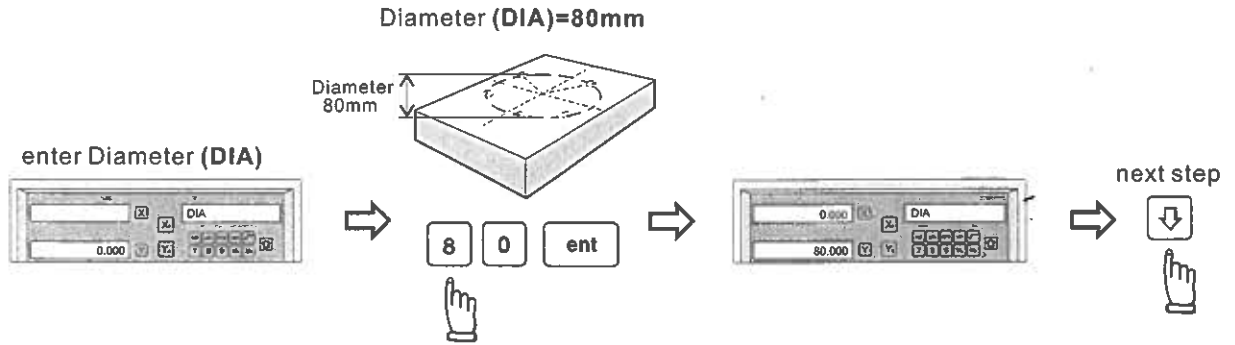

Step 4: Enter No.of Holes (NO.HOLE)

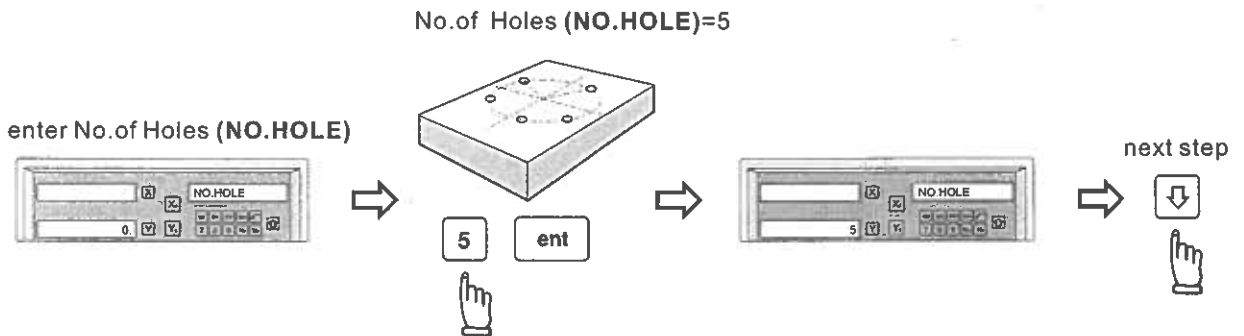

Step 5: Enter the Start Angle (ST.ANG)

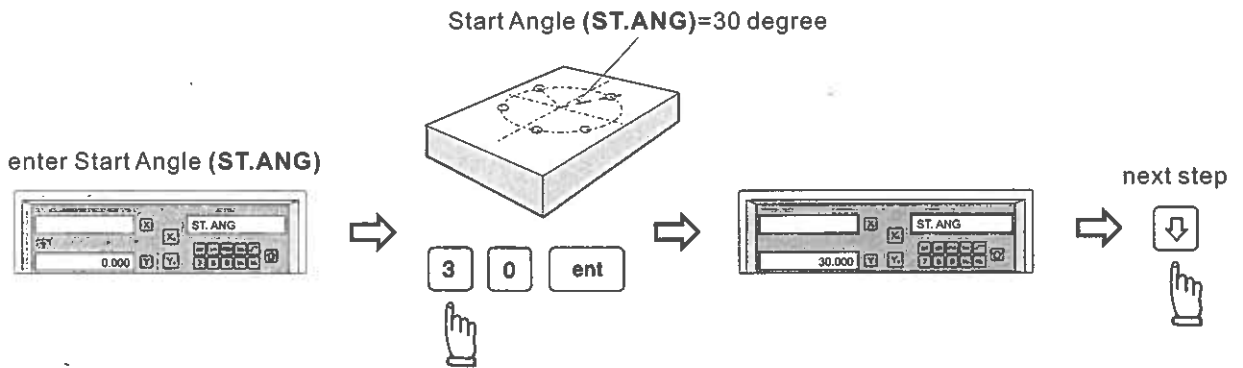

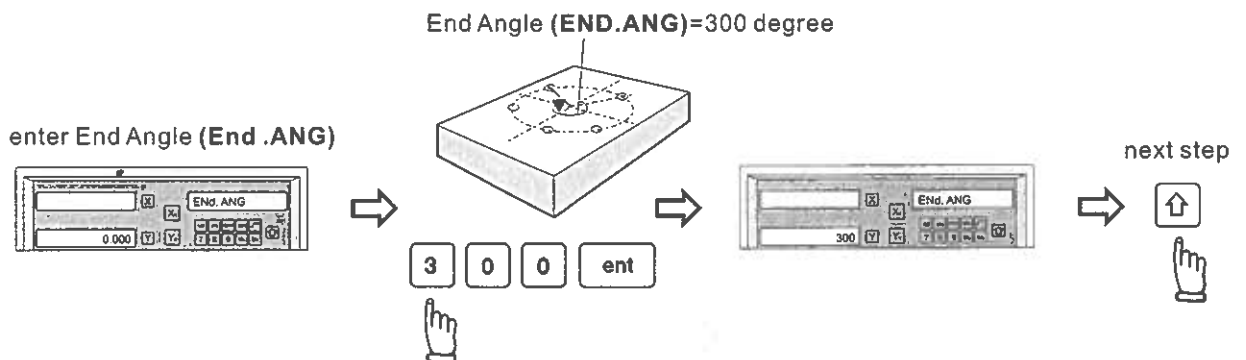

Step 6: Enter the End Angle (END.ANG)



PCD - Tool positioning for Pitch Circle Diameter

All PCD machining parameters  to enter into PCD drilling mode already entered into Counter

Operator can  or  to select the pitch hole, then move the machine to display=0.000, then the pitch hole position is reached.

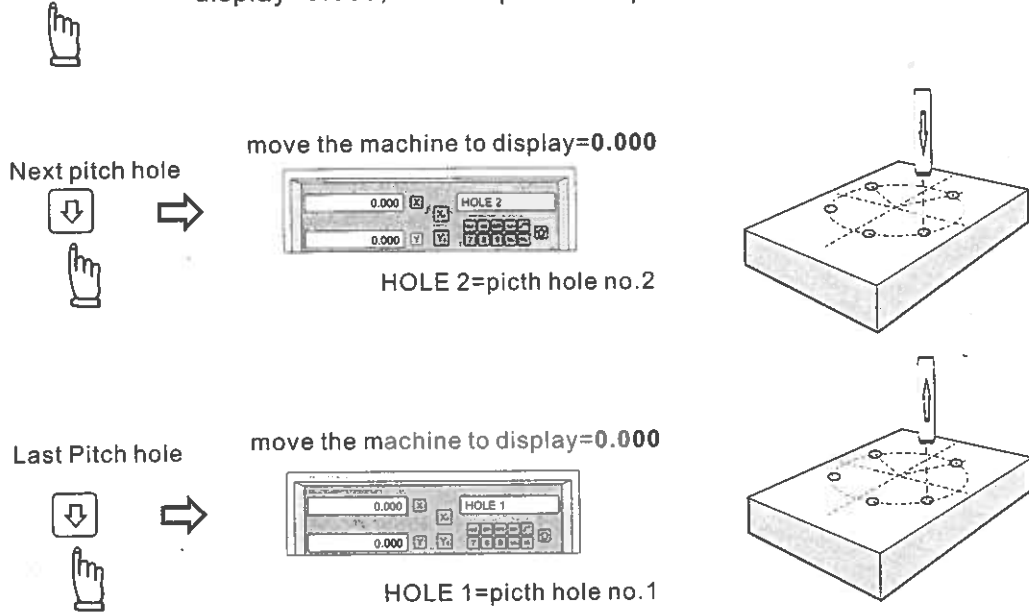

Any time the operator want to check or verify if Counter' sPCD calculation correct or not, or want to temporarily exit the PCD function cycle (swap to normal XYZ display). Operation are as follows:.

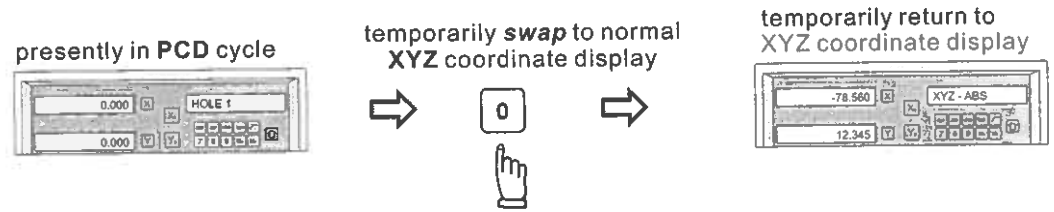

swap back to PCD cycle to continue the PCD hole drilling

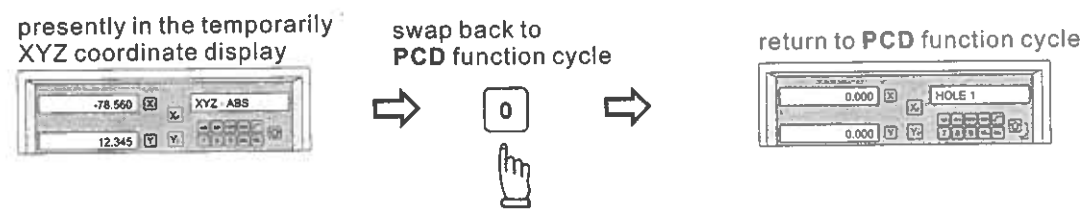

After the PCD hole drilling operation completed, to quit from the PCD function cycle, procedure are as follows

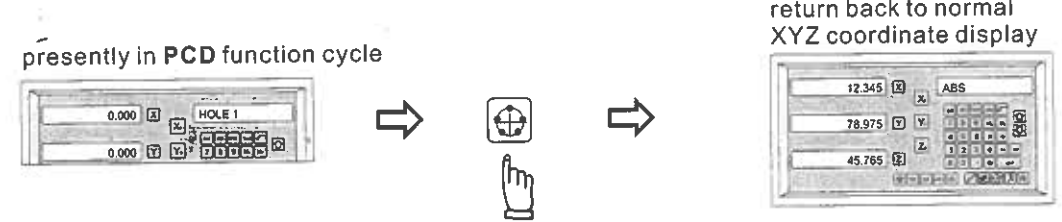

tool positioning for ARC machining

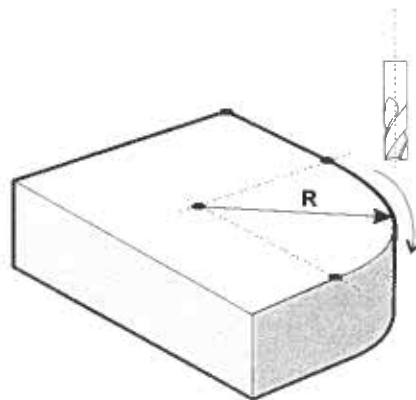
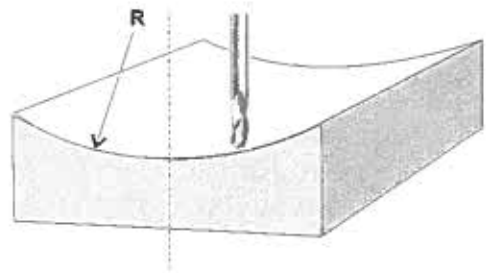
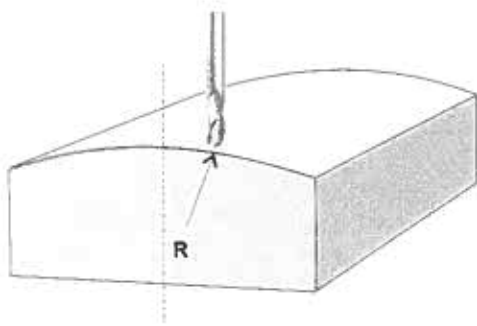

tool positioning for ARC machining

Function: During daily machining, it is quite frequently to machining a round corner or arc surface, especially in mould making.

Of course, if the arc surfaces is complicated or quite a number of round corners have to be machined, or very precise arc or round corners needed to be machined, then CNC milling machine should be used.

But there is still a lot of the cases that only very simple arc surface or only one or two round corners needed to be machined. The precision of those arc or round corners machining are not demanding at all (especially in mould making). If we do not have a CNC machine in house, it is then more cost effective and time saving to carry out those relatively simple arc or round corners machining on your manual milling machine in house rather than sub-contract those CNC machining to an external sub-contractor.

In the past, many mould makers made their tool positioning calculations for ARC machining with a scientific calculator. But the process is time consuming and easily make mistake.

Counter features with a very easy to use tool positioning function for ARC machining which enable mould makers to machine simple ARC in shortest possible time. But before you make your decision to use the ARC function or to have your work piece to be machined in a CNC machine, Please bear in mind that ARC function only cost effective and time saving under following conditions

- 1) One off job
- 2) Only simple ARC surface or round corners to be machined.

ARC functions groups

In Counter, the ARC function group consists of two functions as follows

R function

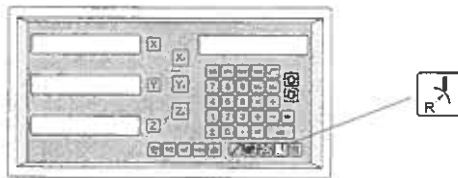

R function provides maximum flexibility in ARC machining the ARC sector to be machined is defined by the coordinates of:

- 1) ARC centre; 2) ARC Radius; 3) ARC start point
- 4) ARC end point

Advantage: -

-Very flexible, R function can machine virtually all kind of ARC, even the intersected ARCs.

Limitation:

-Relatively a bit complicated to operate, operator need to calculate and enter the coordinates of ARC centre, start point and end point into counter.

Simplified R function

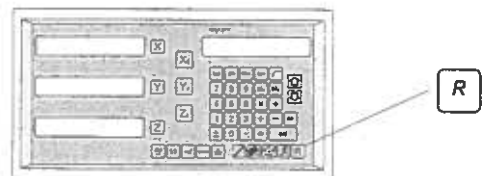

Since Counter's ARC function is aimed to machine only simple ARC or round corners, to make the operation really very simply to operator, Counter preset the eight type of most frequently used ARC machining process into the Counter.

Advantage:

-Very easy to use, operator don't even need to calculate the ARC parameters, just posit the tool at the start point, and then can start the ARC machining right away.

Limitation:

-Restricted to eight type of preset ARC only, cannot machine more complicated ARC such as intersected ARCs.

Understanding Coordinate System:

For those operator whom don't have experience in CNC programming, or the first time user of Counter's R functions, they may find that it is difficult to understand what is coordinate.

The coordinate is a pair of number which specify a position.

When using Counter's R function, it is necessary to enter the coordinates of ARC center, start point, end point and etc. to let Counter know the geomtery of the ARC to be machined.

During installation, normally our service engineer will set the display direction same tñe the dial of the machine. For a Taiwanese made knee type machine, because the lead screw dial direction are as follows the Counter display directions are also be normally set as follows.

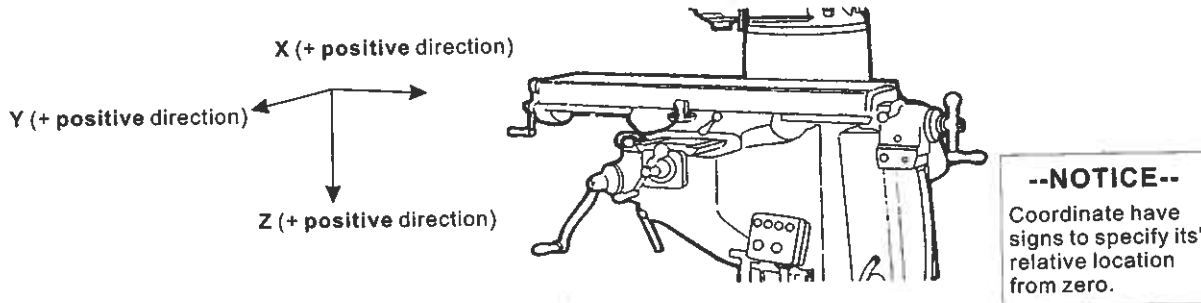

Coordinate Example

Coordinate is a pair of unnumber which specify the distance from the datum point (zero position), the number can be either be positive or negative depends on the relatively direction from the zero position

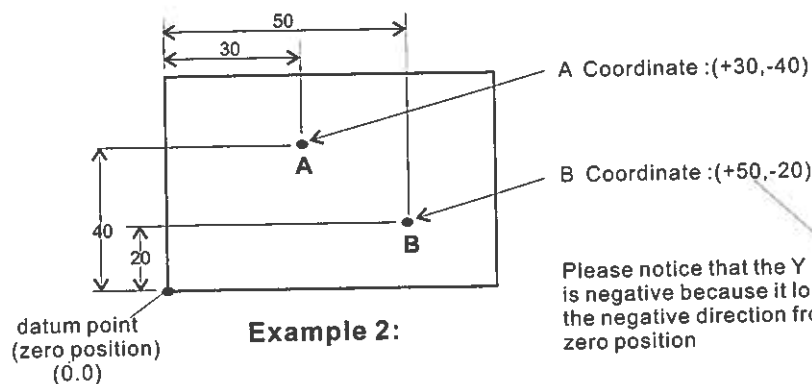
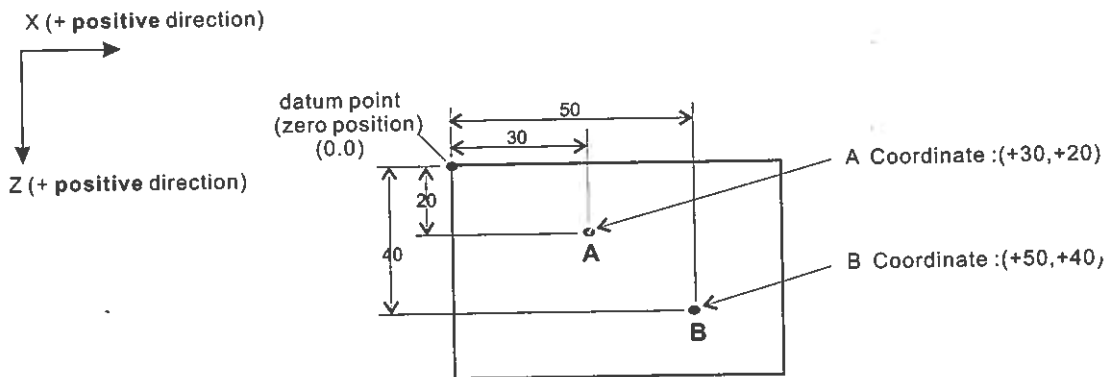

Please notice that the Y coordinate is negative because it located at the negative direction from the zero position

R function

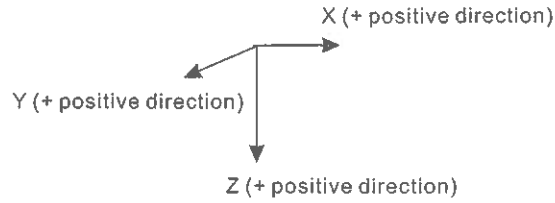

Example 3:

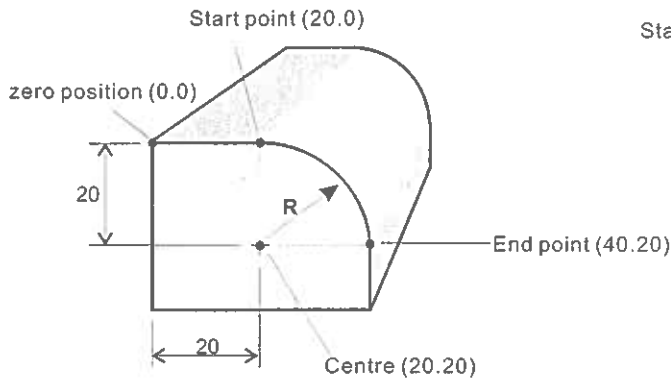

Example 4:

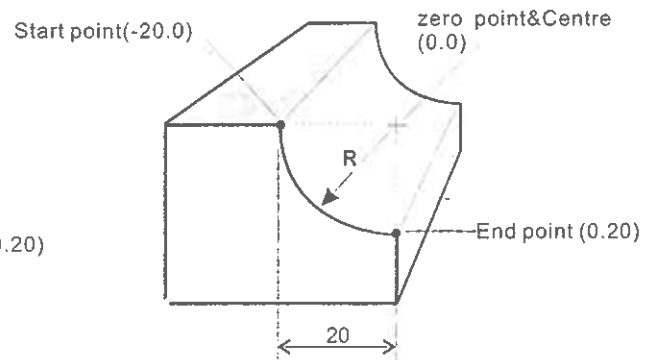

Work plane :

The R function of Counter allows operator to machine R in XY, XZ & YZ plane as per following picture shows. Even for 2 axis DRO, Counter can calculate all the ARC machining positions on XZ & YZ work planes. Therefore, it is necessary to select the work plane required as one of the machining parameters entered into the Counter during in R function data entry.

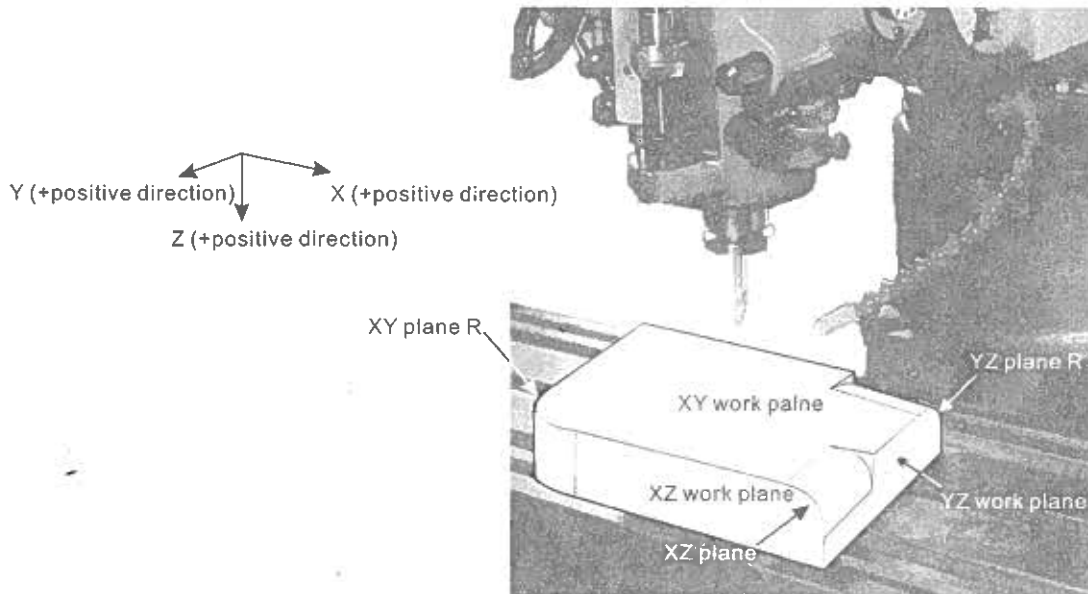

Following parameters needed to enter into Counter for ARC machining:

1. Select work plane -XY,XZ or YZ plane R

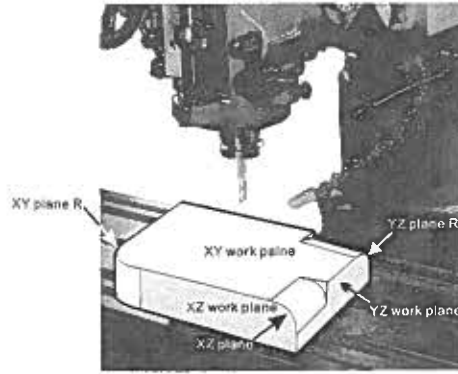

2. R's Centre (CENTRE)

3. R's Radius (R)

4. R's start point (ST.PT.)

5. R's end point (End PT.)

6. Tool Diameter (TOOL DIA)

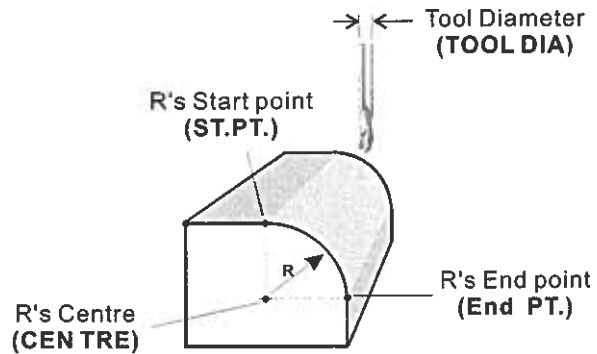

7. Select Tool radius compensation (R+TOOL) or (R-TOOL)

	(R+TOOL)	(R-TOOL)
XZ / YZ plane R		
XY plane R		

8. Machining step Increment

XY plane R	XZ / YZ plane R	
<p>For XY plane R, Max. distance between interpolated points is to be specified as the machining step increment.</p> <p>MAX CUT= max. distance between interpolated points.</p>	<p>For XZ/YZ plane R, under normal condition, the Z step increment is fixed and to be specified as the machining step increment.</p> <p>Z STEP= fixed increment per step</p>	<p>For XZ/YZ plane R, under smooth R option selected, Counter will calculate the Z step increment so that the Max. distance between each machining point approximately the same.</p> <p>MAX CUT= max. distance between interpolated points.</p>

R function

Example :

To machine an **XZ plane R** using 2 Axis **Counter**

Following machining parameters have to enter into **Counter**:

1. Select XZ plane R (S.R-XZ)
2. Centre (**XZ CENTR**).....**X=20.000,Z=20.000**
3. Radius (**R**)**20.000**
4. Start point (**XZ ST.PT**).....**X=20.000,Z=0.000**
5. End point (**XZ END P**).....**X=40.000,Z=20.000**
6. Tool diameter (**TOOL DIA**) ...**6.000mm**
7. Tool Compensation - (**R+TOOL**) Actual ARC Radius=**R+Tool Radius**
8. Z increment per step machining (**Z STEP**)**0.3mm**

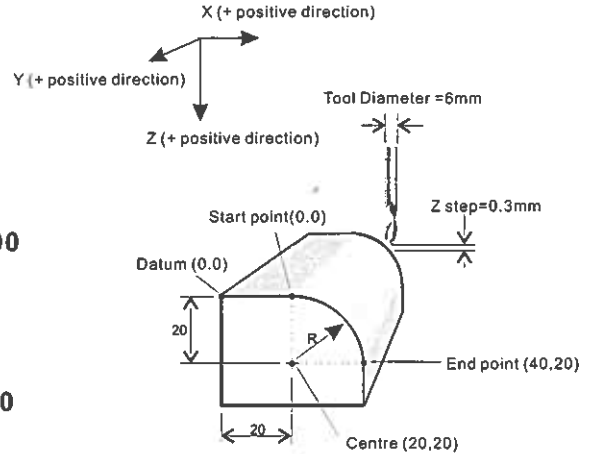

Operation Example

Posit the tool at the start point of the ARC

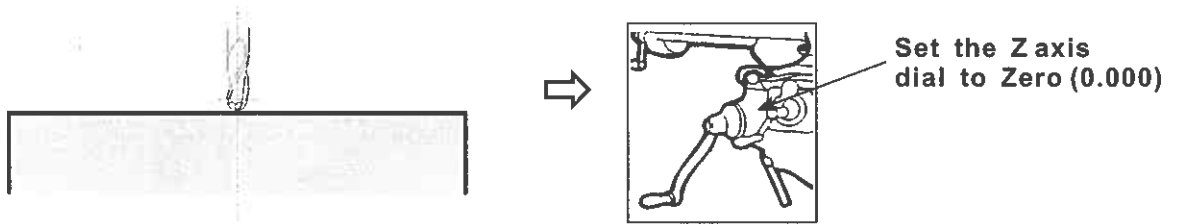

Step 1: select work plane :XZ plane R(S.R-XZ)

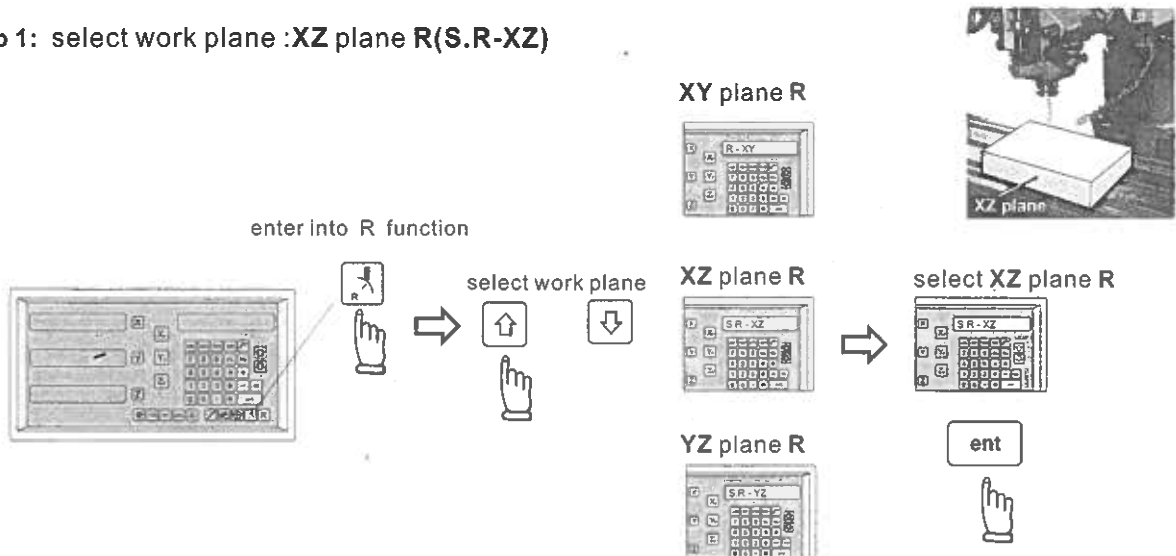

Step 2: enter the Centre's coordinate (XZ CENTR)

centre coordinate (XZ CENTR):X=20.000,Z=20.000

enter centre's coordinate (XZ CENTR)

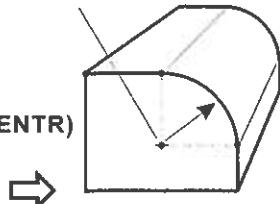
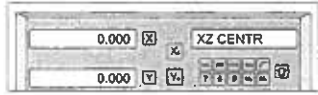

X 2 0 ent

Y 2 0 ent

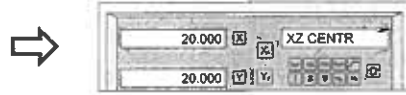

next step



— since two axis counter do not have Z axis use Y axis to enter Z coordinate

Step 3: enter the Radius (R)

Radius (R)=20mm

enter Radius (R)

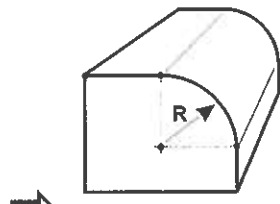
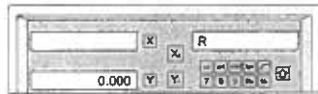

2 0 ent

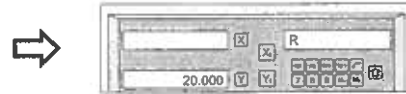

next step



Step 4: enter the Start point's coordinate (XZ ST.PT)

start point's coordinate (XZ ST.PT):X=20.000,Z=0.000

enter Start point's coordinate (XZ ST.PT)

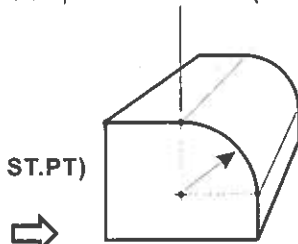
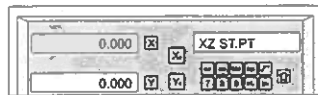

X 2 0 ent

Y 0 ent

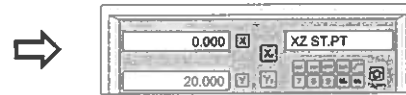

next step



— Since two axis Counter do not have Z axis use Y axis to enter Z coordinate

R function

Step 5: enter the end point's coordinate (XZ end p)

end points' coordinate (XZ End P): X=40.000, Z=20.000

enter End point's coordinate (XZ End P)

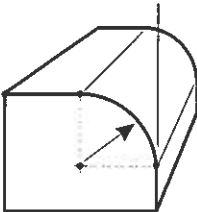

next step



→



X 4 0 ent

Y 2 0 ent

— since two axis Counter do not have z axis use Y axis to enter Z coordinate

→



↓



Step 6: enter the tool diameter(tool dia)

enter Tool diameter (TOOL DIA)

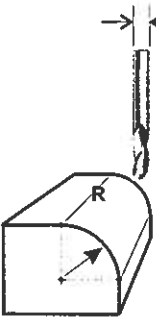

Tool Diameter = 6mm

next step

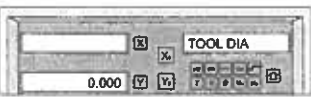

→

6 ent

→



↓



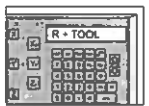

Step 7: select tool compensation direction

(R+TOOL)



↑ ↓

(R-TOOL)



→

select (R+TOOL)

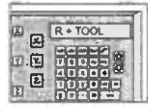

→

next step

↓



ent

Step 8: enter Z increment per step machining

Counter provides two options on the Z increment per step machining. Operator can enter their selection on the smooth R function.

Option 1 : Fixed Z step (Z STEP)

Under this option, the Z increment per step machining is fixed, since the ARC's curvature is vary with their Z position, operator have to use their experience to select different Z STEP increment during the ARC machining to get optimal and fastest machining

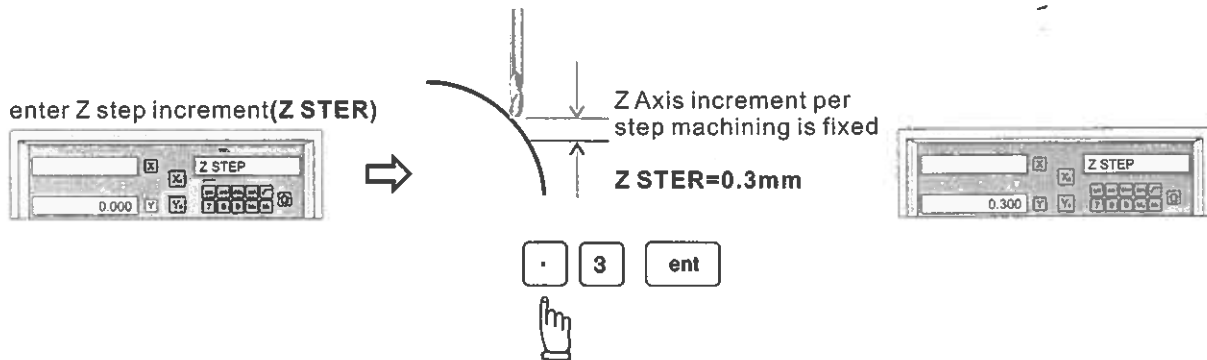

Option 2: Maximum Cut(MAX CUT)

Under this option, Counter will calculate the best possible Z increment per step machining according to the curvature of ARC, to make the interpolated point approximately equal to the MAX CUT entered.

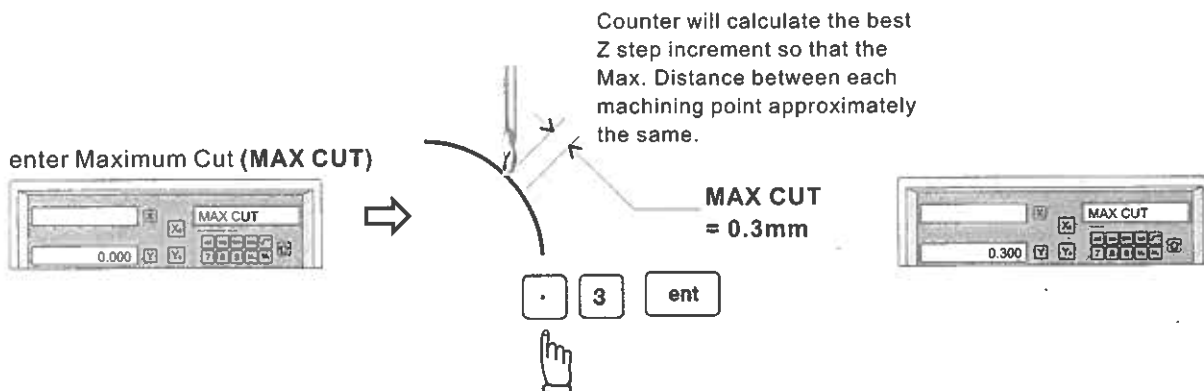





All R function machining parameters have already entered into Counter



to enter into ARC machining mode





Since two Axis Counter do not have Z Axis,  and  to simulate the z axis movement therefore, Counter use the

 — Simulate Z axis move up one step  Simulate Z axis move down one step

before the start of ARC machining, planese make sure the tool is posited at the ARC starting point and Z axis dial is set to zero (0.000)

two axis Counter machining mode

During the XZ or YZ plane R machining, it is necessary to accurately posit the Z axis to obtain a precise Z position. However, there is no Z axis in the two axis Counter. Therefore, in order to guide the operator easily posit the Z axis during the ARC machining. Counter use the unused axis display to display the **Z dial turn number** and **Z dial reading** to guide the operator posit the Z axis.

At the beginning of the ARC machining, the Counter will start and assume the Z axis dial at zero position with the tool positioned at the starting point of the ARC. then press the  and  once to simulate Z axis move up or down the Z axis for one step, the corresponding Z dial turn number and Z dial reading will display on the Unused axis Operator just need to move the Z axis according the dial reading display on this axis, then the correct Z axis height is reached.

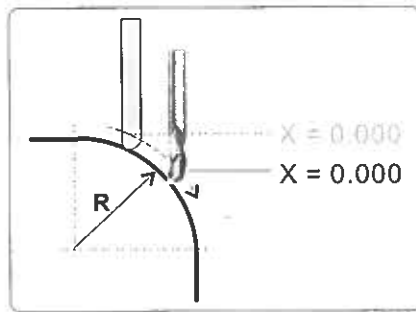

Move the X axis until display =0.000, then the tool is posited on the ARC curve

The display will **shift left** to signify it is not normal coordinate display

move the Z axis according to the dial settings displayed on Y axis

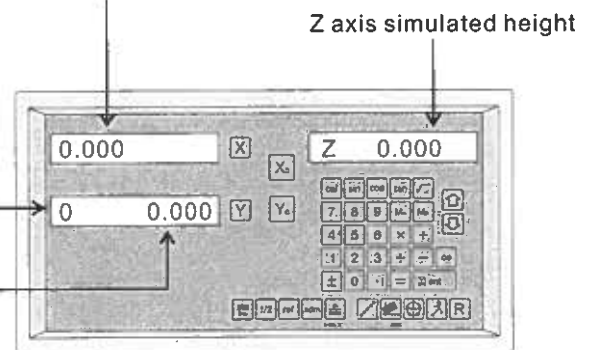
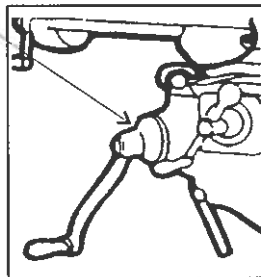

Display data in XZ plane R machining mode

If the Z axis is posited outside the R curvature, Counter will display "ZOULI"(Z OUT LIMIT)

R function

Anytime the operator want to check or verify if Counter's **R** calculation correct or not, or want to temporarily exit the **R** function cycle (swap to normal XYZ display). Operation are as follows:.

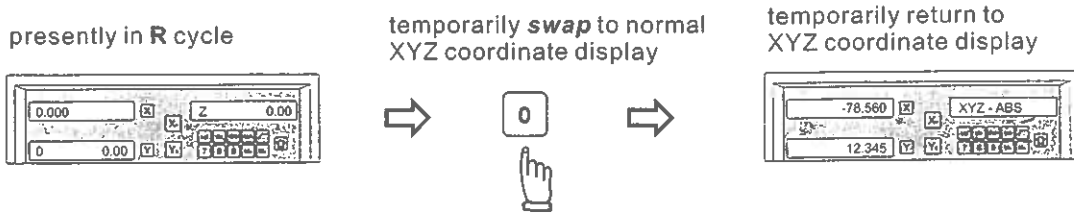

swap back to R cycle to continue the R machining mode

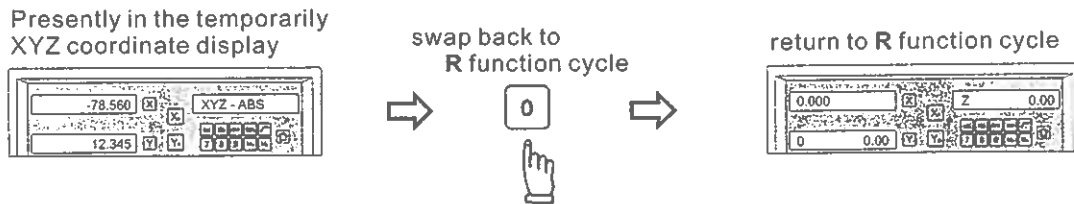

If fixed **Z STEP** option chosen, the **Z STEP** increment can be change anytime during the ARC machining

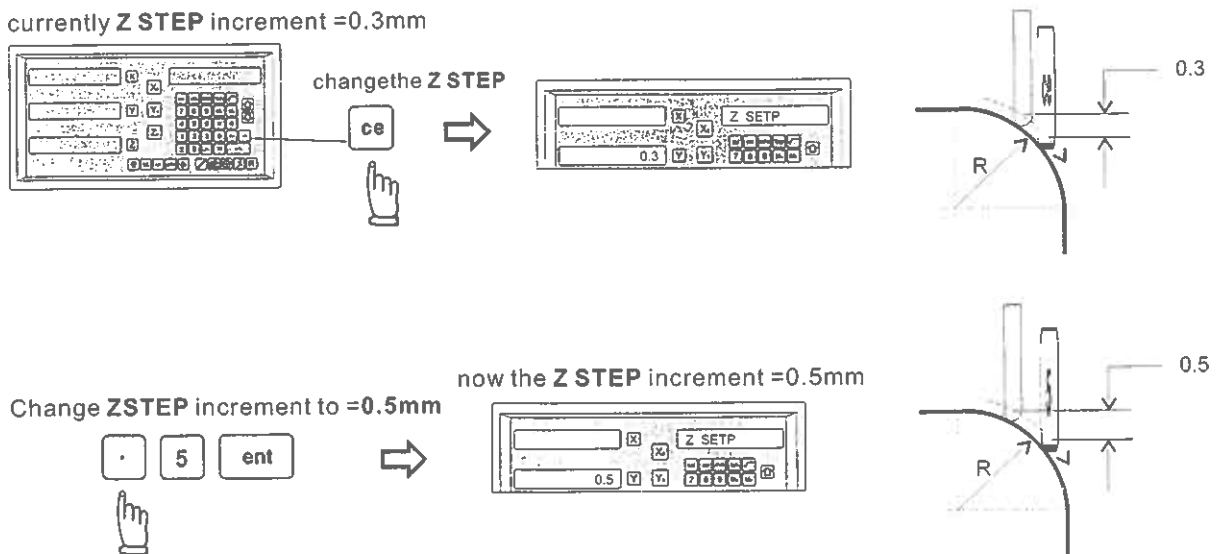

Simplified R function

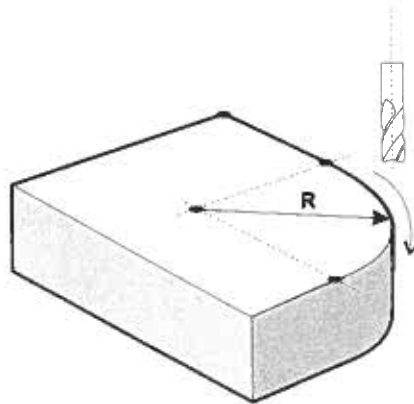
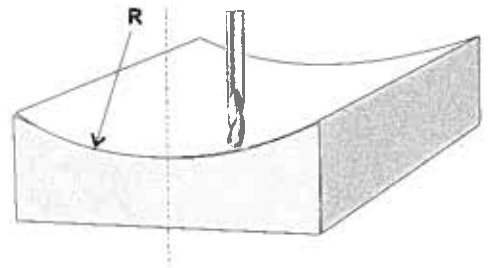
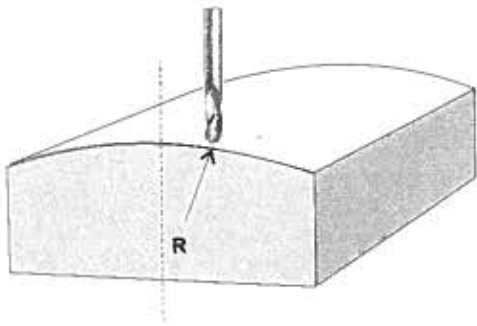

Simplified R function

Function : Since the R function of Counter is designed to machine simple ARC, in fact, after concluded from our years of experience in DRO, we have found that over 95% of the case, our customer just use the Counter to machine very very simple ARC. But they found that the parameters entry of R function is quite complicated to them.

Therefore, Counter provides a very easy to use R function to enable operator machine simple R in a very short time.

In majority of the case, only eight type of ARC used to be machine. The Counter hence built in those 8 type of R, operator just select the type of R they needed to machine, input the Radius, tool compensation and increment per machining step. Then they can start the ARC machining right away.

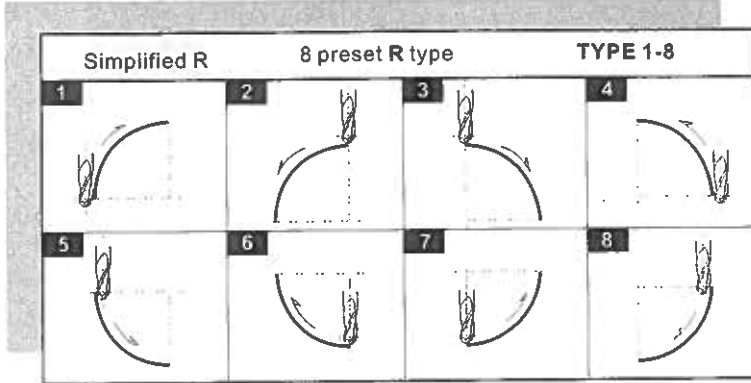

Using Ball Nose slot drill to machine XZ/YZ plane R

Using 4 Flute End Mill to machine XZ/YZ plane R

please notice that when using flat end end mill to machine R, as we are actually using the sharp corner for cutting therefore the TOOL DIA must be set to 0.000

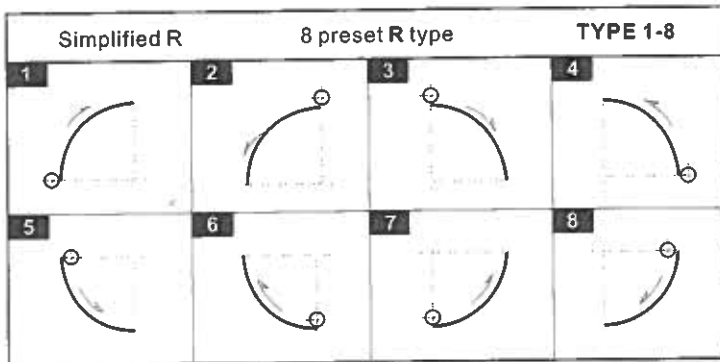
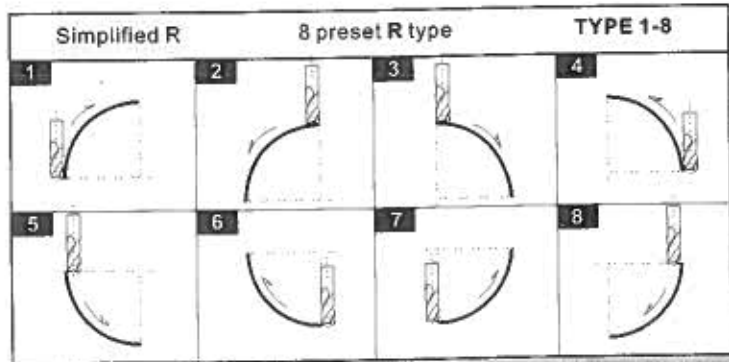

Using two Flute (SLOT DRILL) for XY plane R

Simplified R function

The operation procedures of Simplified R are as follows

posit the tool at the ARC starting point

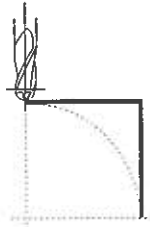

set the Z dial to zero

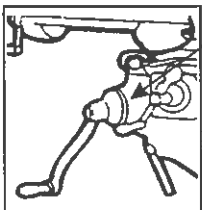

enter into Simplified R function

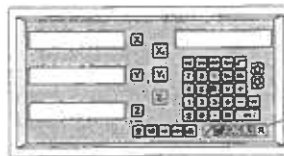

Following parameters needed to enter into Counter for ARC machining:

1. Select work plane-XY,XZ or YZ plane R

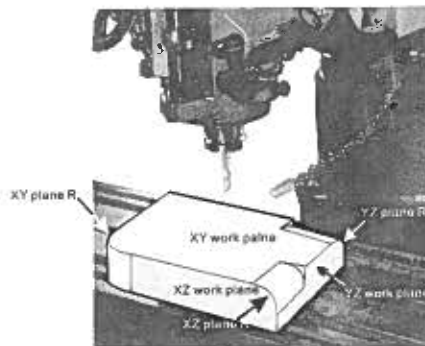

2. Select the R type (R TYPE) -Type 1 to 8

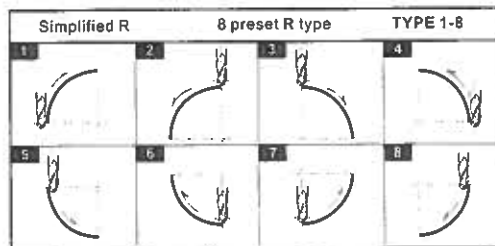

3. Radius (R)

4. Tool diameter (TOOL DIA)

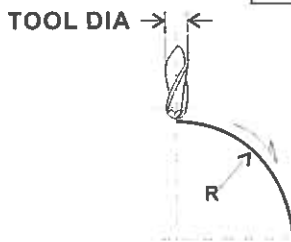

5. machining step Increment

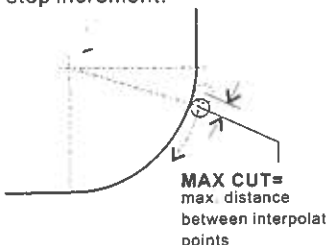
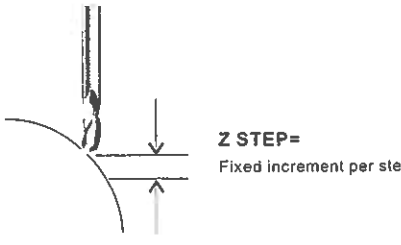
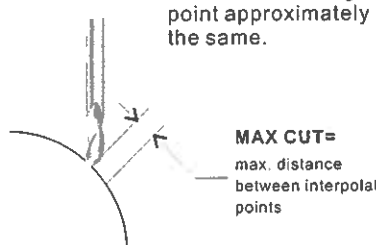
XY plane R	XY/YZ plane R	
<p>For XY plane R, Max. Distance between interpolated points is to be specified as the machining step increment.</p>  <p>MAX CUT= max distance between interpolated points</p>	<p>For XZ/YZ plane R, under normal condition, the Z step increment is fixed and to be specified as the machining step increment.</p>  <p>Z STEP= Fixed increment per step</p>	<p>For XZ/YZ plane R, under smooth R option selected, Counter will calculate the Z step increment so that the Max. distance between each machining point approximately the same.</p>  <p>MAX CUT= max. distance between interpolated points</p>

Simplified R function

Example :

To machine the copper electrode as shown which have an ARC of **R=200mm** usinga Two Axis Counter

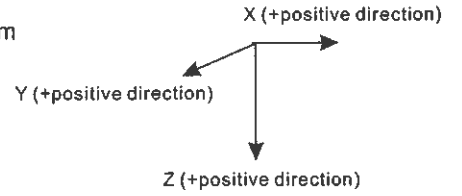
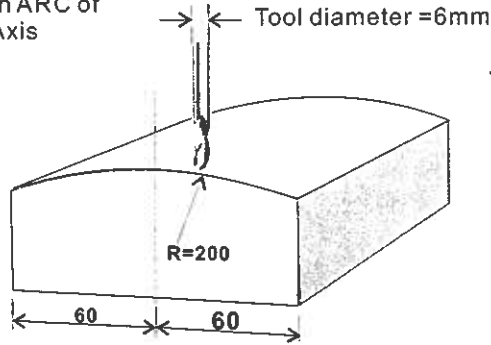

Operation procedures

Because Counter's XZ/YZ can only machine an arc which is less than 90 degrees,therefore, it is necessary to divide this arc machining into twoparts.



First Part
Use Preset R type 2

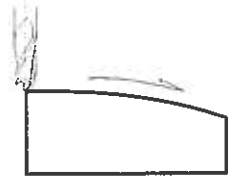

Second Part
Use Preset R type 3

posit the tool at the ARC starting point (surface of the work piece centre in this case)

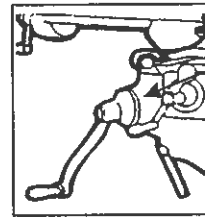
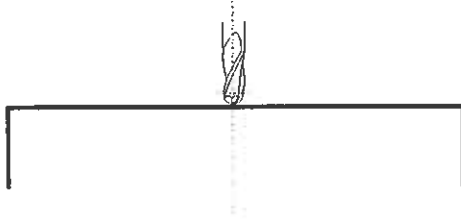

set the z dial to zero

Step 1: select work plane : XZ plane R (S.R-XZ)

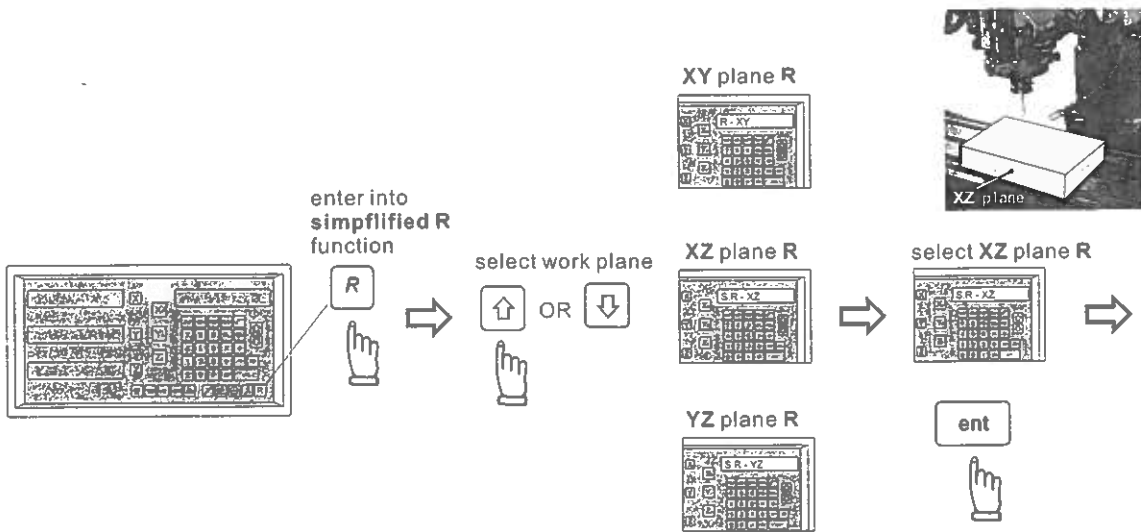

Simplified R function

Step 2 : select preset R type (TYPE 1-8)

Select R type (TYPE 1-8)



For the first part select preset R type 2 (TYPE=2)

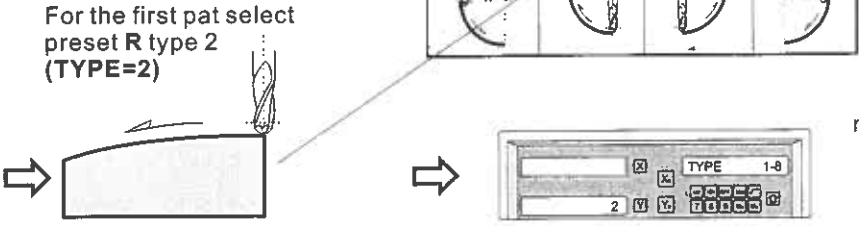

Simplified R	8 preset R type	TYPE 1-8	
1	2	3	4
5	6	7	8

next step



2 ent



Step 3 : enter Radius (R)

enter Radius(R)

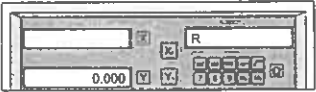

Radius (R) = 200mm

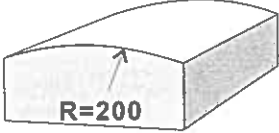

next step



2 0 0 ent



Step 4 : enter Tool diameter (TOOL DIA)

enter Tool diameter (TOOL DIA)



Tool diameter = 6mm

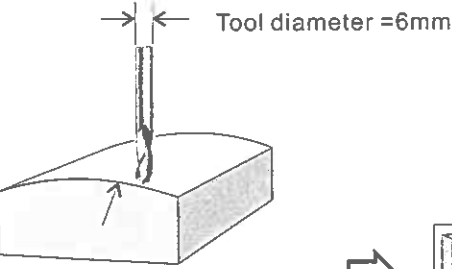

next step



6 ent



Simplified R function

Step 5 : enter z increment per step machining

Counter provides two options on the z increment per step machining. Operator can enter their selection on the smooth R function.

Option 1: Fixed Z step (Z STEP)

Under this option, the Z increment per step machining is fixed since the ARC's curvature is vary with their Z position, operator have to use their experience to select different Z STEP increment during the ARC machining to get optimal and fastest machining

enter Z step increment (Z STEP)

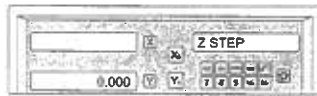

Z Axis increment per step machining is fixed

Z STEP=0.3mm

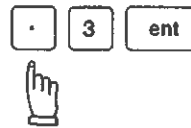
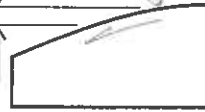

Option 2: Maximum Cut (MAX CUT)

Under this option, Counter will calculate the best possible Z increment per step machining according to the curvature of ARC, to make the interpolated point approximately equal to the MAX CUT entered.

enter Maximum Cut(MAX CUT)



Counter will calculate the best Z step increment so that the Max. distance between each machining point approximately the same

MAX CUT = 0.3mm

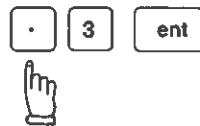
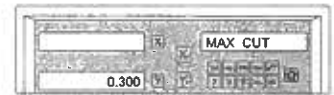



All simplified R function machining parameters have already entered into Counter



to enter into ARC machining mode



Since two Axis Counter do not have Z Axis, therefore, Counter use the  and  to simulate the Z axis movement



 — simulate Z axis move up one step

 — simulate Z axis move down one step

before the start of ARC machining, please make sure the tool is posited at the ARC starting point and z axis dial is set to zero(0.000)

two axis Counter-ARC machining mode

During the XZ or YZ plane R machining, it is necessary to accurately posit the Z axis to obtain a precise Z position. However, there is no Z axis in the two axis Counter. Therefore, in order to guide the operator easily posit the Z axis during the ARC machining. Counter use the unused axis display to display the **Z dial turn number** and **Z dial reading** to guide the operator posit the Z axis.

At the beginning of the ARC machining, the Counter will start and assume the Z axis dial at zero position with the too posited at the starting point of the ARC .then press the  and  once to simulate Z axis move up or

down the Z axis for one step, the corresponding Z dial turn number and Z dial reading will display on the unused axis. Operator just need to move the Z axis according the dial reading display on this axis, then the correct Z axis height is reached.

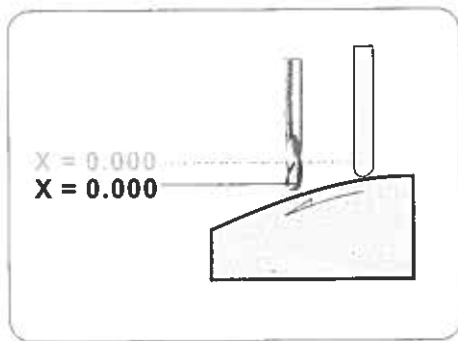

Move the X axis until display =0.000, then the tool is posited on the ARC curve

The display will shift left to signify it is not normal coordinate display

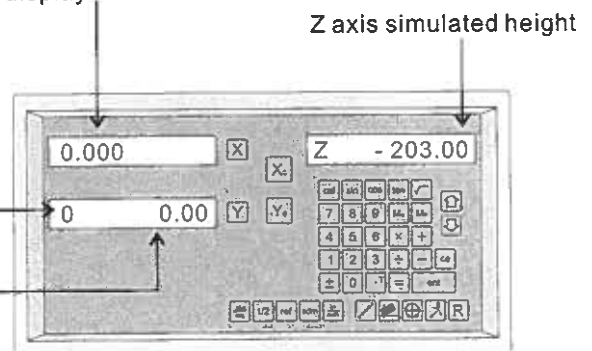

Z dial turn number

Z dial reading

move the z axis according to the dial settings displayed on Y axis

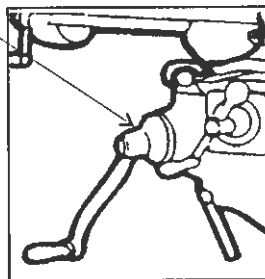

Display data in XZ plane R machining mode

If the Z axis is posited outside the R curvature, Counter will display "Z OU LI"(Z OUT LIMIT)

two axis Counter-ARC machining mode

Anytime the operator want to check or verify if Counter's **Simplified R** calculation correct or not, or want to temporarily exit the **R** function cycle (swap to normal XYZ display).Operation are as follows:

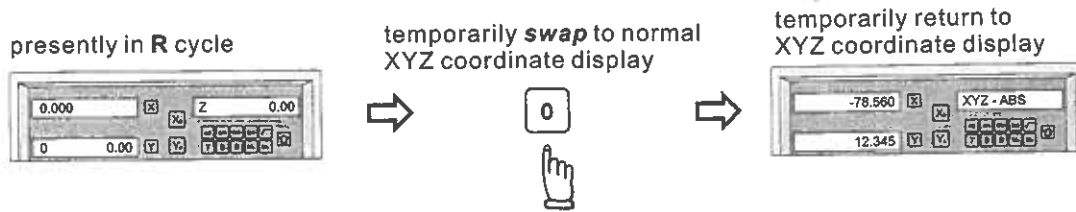

Swap back to R cycle to continue the R machining mode

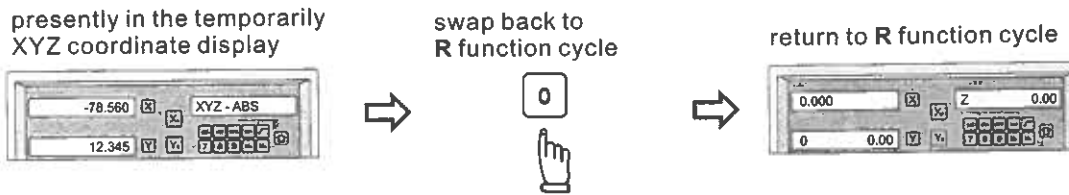

If fixed **Z STEP** option chosen, the **Z STEP** increment can be change anytime during the ARC machining

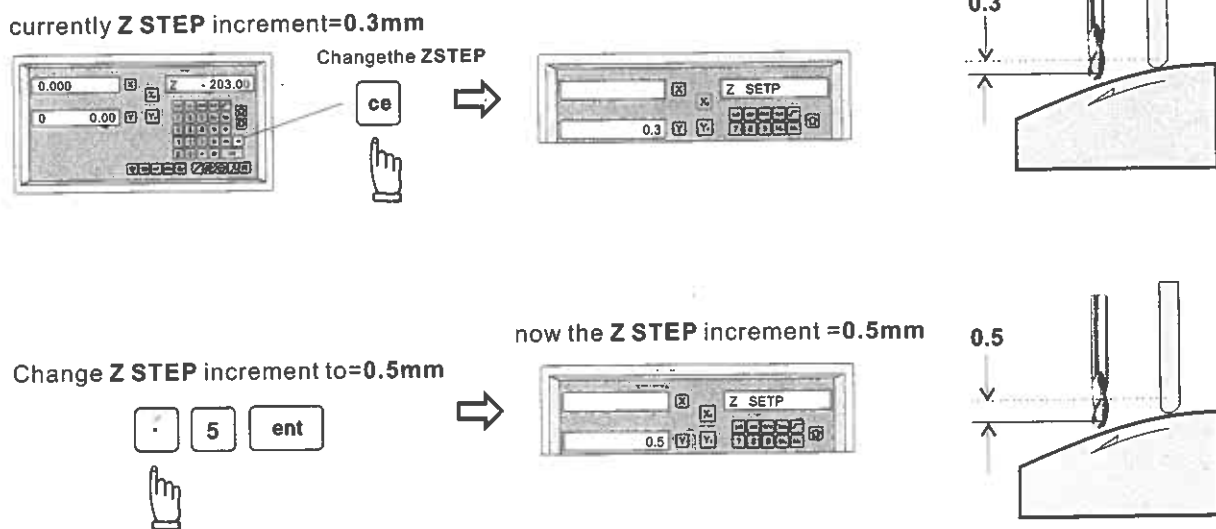

Shrinkage Calculation

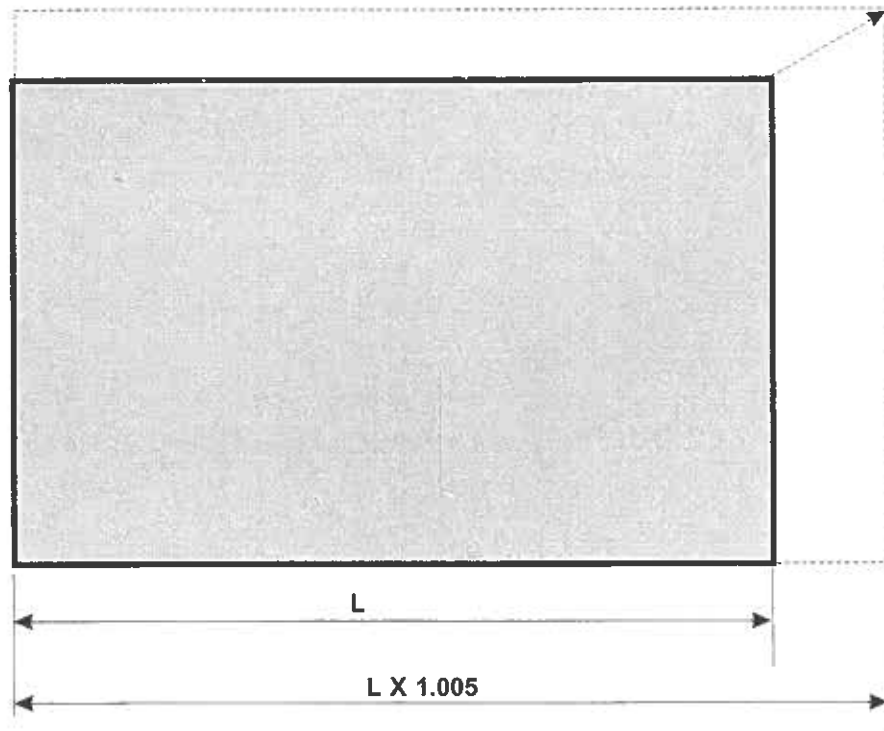

Shrinkage calculation

function : Because plastic material shrinks during cooling after the plastic injection process, therefore, when making a mould for plastic injection, the dimensions of the mould cavity have to be expanded or reduced according to a "shrink factor", i.e. for normal ABS material, the "shrink factor" is 1.005.

Normally, the mould maker has to calculate all the reduced or expanded dimensions prior to the actual machining, marking down the dimensions on the drawing. The pitfalls of this method areas follows:

- 1) It is a very time consuming process
- 2) Because there are a lot of calculations, it is inevitable that some calculation mistakes, or incomplete calculation (some calculations are omitted by mistake) occurs. There is also no easy method of verifying the calculated dimensions and it is too easy to make mistakes, subjecting the operator to heavy psychological pressure.
- 3) Mould work has to be correct first time, bearing in mind the cost of the product.

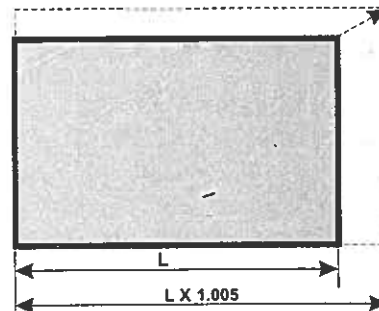

ES-8 provides practical "SHRINKAGE CALCULATION" function to help the mould makers calculate the shrinkage and verify the calculated expanded/ reduced dimension.

Operation procedure

1. Entering the "SHRINK FACTOR"

All the shrinkage dimensions are actually the multiples or divisions of a shrinkage factor, the shrinkage factors change for different plastic material. Before machining the operator must enter the shrink factor into the **ES-8**.

Example : For material (ABS plastic), the shrink factor is 1.005.

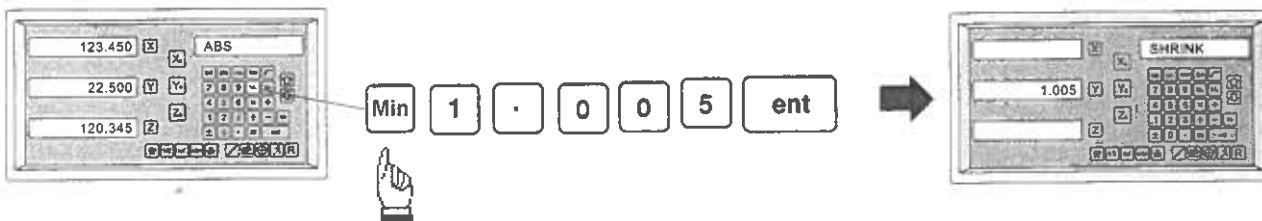

Shrinkage calculation

2. Shrinkage Calculations

ES-8 provides a very easy-to-use shrinkage function, and allows the operator to easily calculate the expanded or reduced dimensions.

It is normally used in a case where incomplete shrinkage calculation have been made, ie some dimensions have been forgotten to be marked onto the drawing. Using the ES-8 during the machining process, the operator can calculate the shrinkage dimensions directly with the readout. ES-8 also provides an easy method of verifying the calculated dimension marked on the drawings.

ES-8 uses



for expand calculation



for shrink calculation

Example : To calculate the expanded dimension of 27mm

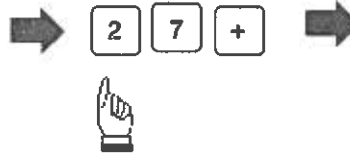
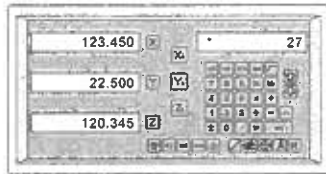

27mm expand = $27 \times 1.005 = 27.135$
Calculation result will display in the message window

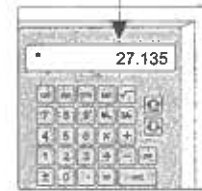

Example : To calculate the shrunk dimension of 27mm

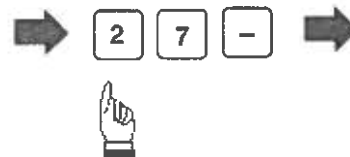
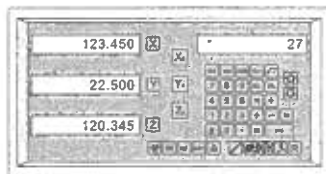

27mm shrink = $27 / 1.005 = 26.866$
Calculation result will display in the message window



Example : To calculate the expanded dimension of current X axis dimension

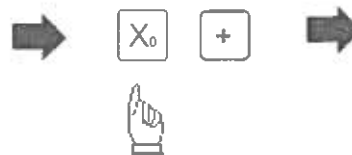
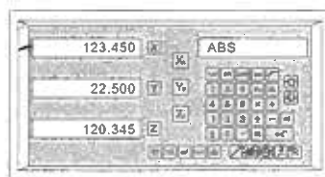

The current position of X axis is 123.45, therefore,
 $123.45 \text{ mm expands} = 123.45 \times 1.005 = 124.067$
Calculation result will display in the message window

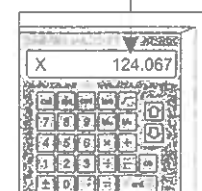

3. Shrinkage Compensation

When the operator is familiar with the shrinkage function of ES-8, instead of calculating all the shrink dimensions and marking them onto the drawing, the operator can use the shrinkage compensation features of the ES-8 which actually expand or reduce all display dimension according to the multiples of the shrink factor, thereby, the need to calculate all the working dimensions one by one.

If the operator still insists that they have more confidence by calculating all shrink dimensions prior to the actual machining process and marking them on the drawing, the ES-8 shrinkage compensation function can still be used to provide a very efficient way of verifying the operator's calculated dimensions, marked on the drawing by using the "Expand" and "Shrink" toggle-function to switch between real-dimension display and shrinkage-compensated-dimension display.

ES-8 uses  for expand calculation

 for shrink calculation

Example : To compensate by "Expand", so that the actual dimensions are the expanded dimension of the ES-8's display dimensions.

Because the display dimension has compensated by the shrink factor, in order to remind operator that ES-8 is currently in shrink compensation mode to avoid operation mistake, ES-8 will display

1. flashing display of "+ SHRINK"
2. get a beep sound for every 10 SEC.
3. disable all functions and function keys

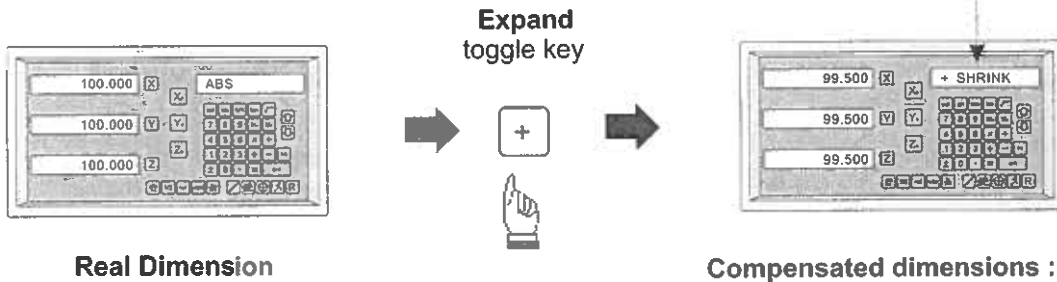

The actual dimension are now X 1.005 of the displayed dimensions

Example : To compensate by "Shrink", so that the actual dimensions are the shrunk dimension of the ES-8's display dimensions.

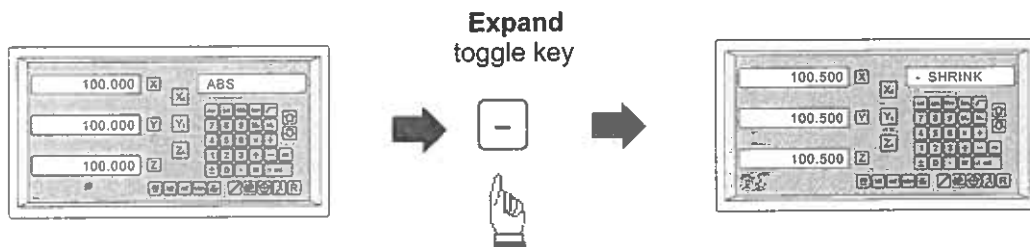

The actual dimension are now / 1.005 of the displayed dimensions

Shrinkage calculation

When the ES-8 is in shrink compensation mode, if the operator wants to return to normal real dimension display.

Press **ce** or **ent**

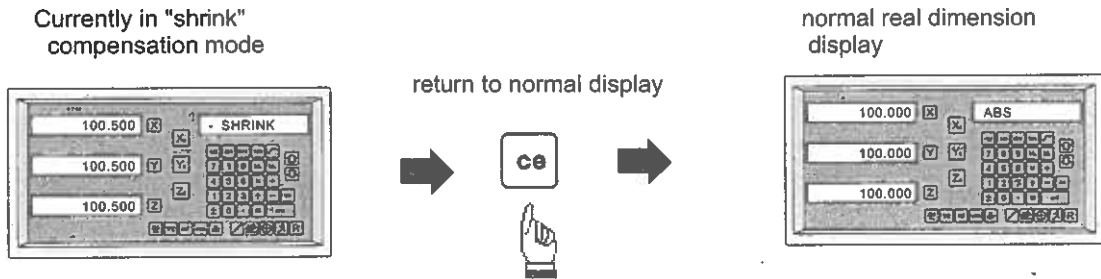

Shrinkage calculation

Example : To drill the following holes in the plastic injection mould

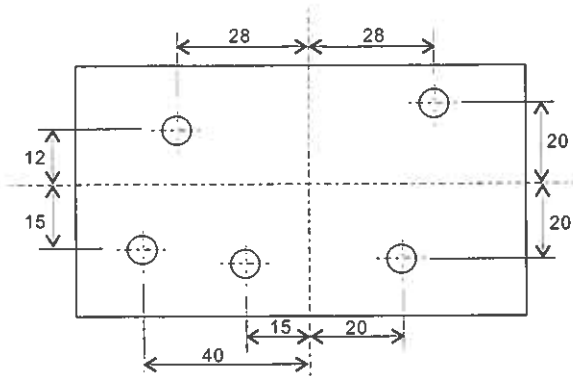

Because the plastic material shrinks when it cools down after the plastic injection process, the dimensions of the holes in the mould have to be expanded according to the shrink factor.

Normally, the operator has to calculate all the expanded dimensions prior to the machining, but with ES-8, the operator can use ES-8's "shrink compensation" function which actually expands the display dimension by the shrink factor, enabling the operator to drill directly according to the dimensions specified in the drawing, obviating the need to calculate the reduced dimensions one by one.

Operation procedure

1. Entering the "SHRINK FACTOR"

i.e : For plastic material (ABS), it's shrink factor is 1.005.

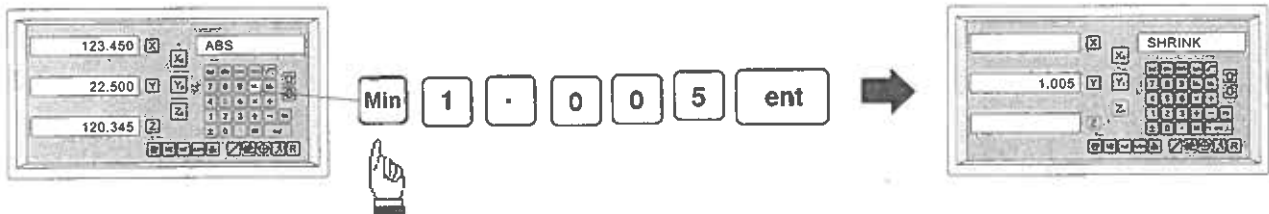

2. Set the ES-8 to "Expand Compensation"

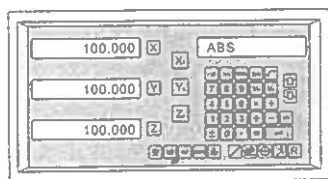

Real Dimension

Expand
toggle key

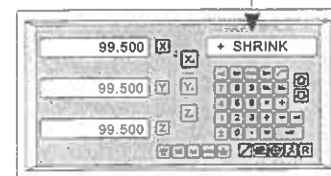
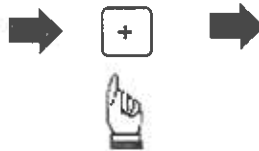

Compensated dimensions :

The actual dimension are now X 1.005 of the displayed dimensions

Operator can drill the holes as above in this mode without the need of calculation

Shrinkage calculation

When the ES-8 is in shrink compensation mode, if the operator wants to return to normal real dimension display.

press **ce** or **ent**

Currently in "shrink"
compensation mode

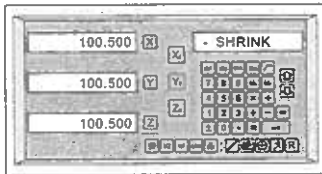

return to normal display



normal real dimension
display

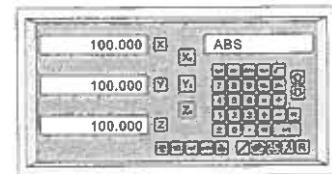

Compensated dimensions :

The actual dimension are now X 1.005
of the displayed dimensions

Real Dimension

After verifying and need further machining in shrink compensated mode

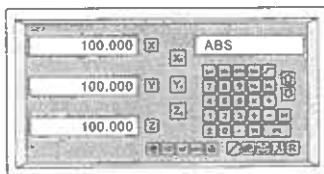

Real Dimension

Expand
toggle key

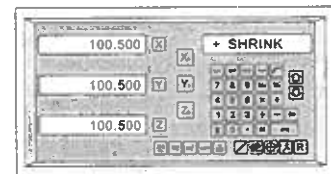
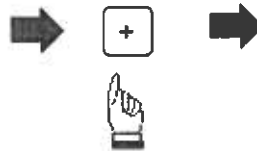

Compensated dimensions :

The actual dimension are now X 1.005
of the displayed dimensions

Operator can drill the holes as above in
this mode without the need of calculation

Parameters Setup

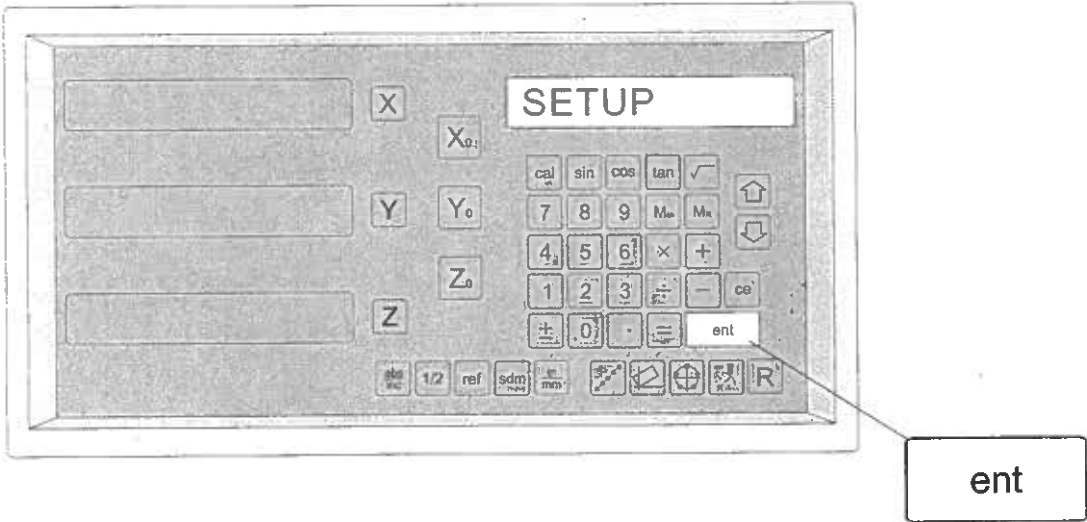

Parameters Setup Procedure

A) Parameters Reset

Each ES-8 is configured as it leaves the factory, however, all parameters memory are backup by the internal battery which can only last 30 days after power switched off. Therefore, if the ES-8 have been power off for more than 30 days, the ES-8 parameters might have to reset or reconfigured. Followings are the parameter reset procedure for ES-8.

Operating Procedure :

1) Switch off the ES-8

2) Switch on the ES-8, after switching on with the software version "VER. ***" showing in the MESSAGE window, press the number "8" key to enter the parameters reset function.

ES-8 proceeds a self test on electronics circuit after switching on



Software Version

With the software version number displayed on the message window, for example "VER. 8M B" press **8** to enter into the reset function



8



3) After entered into the reset function, ES-8 will proceed a "RAM TEST" to test all RAM memory, and also reset all RAM memory to 0. Finally resume all factory default settings.



ES-8 displays "RAM TEST" means RAM test is in progress



ES-8 displays "RAM OK" means RAM memory tested OK.



ES-8 displays "RESET" means all parameters have been resumed to factory default settings

4) Reset completed, the ES-8 will proceed LED display test until switched off.



Reset completed and ES-8 enters into a endless LED test to let operator know if there is any missing segment in LEDs, you can switched off the ES-8 if you found no missing segment in the display LEDs.

B) Parameters Setup

Each ES-8 is configured as it leaves the factory, however, in order to enable each ES-8 to be individually set up for particular machine and application, following SETUP procedure is used

The SETUP procedure is written in a menu mode which enable you to scroll through the top level options and enter, configure and exit the sub-functions as they arise. Press the "UP" or "DOWN" keys to scroll through the menu selections.

The top level menu headers in order are as follows:

DIRECTN specifies the direction of count for each axis

LIN COMP permits linear error compensation to be input

Z DIAL Z axis movement of the milling machine per Z axis Dial turn

This parameter is used only for two axis ES-8 which allows the two axis ES-8 to simulate the Z axis movement for ARC machining function. This parameter is no use at all in three axis ES-8 or when ARC function is not in used.

DIAL INC Z axis dial increment of the milling machine.

This parameter is used only for two axis ES-8 which allows the two axis ES-8 to simulate the Z axis movement for ARC machining function. This parameter is no use at all in three axis ES-8 or when ARC function is not in used.

R MODE specifies the Z axis interpolation method during the ARC function, ES-8 have "MAX CUT" and "Z STEP" for choices. If the user choose "MAX CUT", the ARC function calculation will interpolated the ARC in fixed cutting distance for smooth ARC machining. If user choose "Z STEP", the R function calculation will interpolated the ARC in fixed Z axis increment for easier and quicker ARC machining.

This parameter is used only for two axis ES-8 which allows the two axis ES-8 to simulate the Z axis movement for ARC machining function. This parameter is no use at all in three axis ES-8 or when ARC function is not in used.

QUIT exit the SETUP function.

Parameters Setup Procedure

Followings are the control keys that are used in the **SETUP** function.

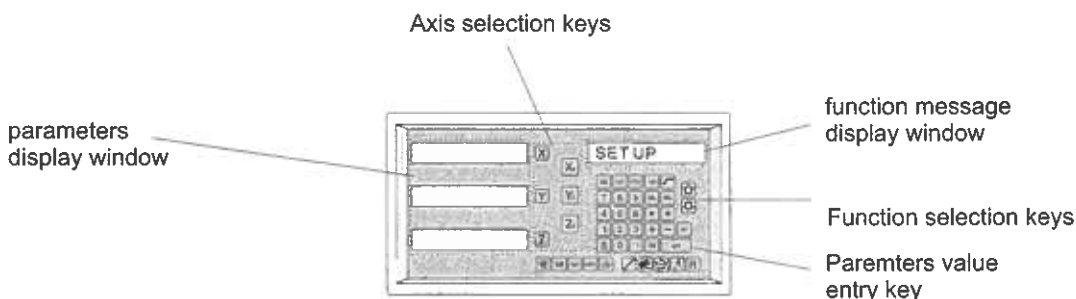



Operating Procedure of **SETUP** function :

To enter into the **SETUP** procedure, after switching on with software version showing in the **MESSAGE** window, press the "ent" key to enter into the **SETUP** function.

1) Switch off the **ES-8**

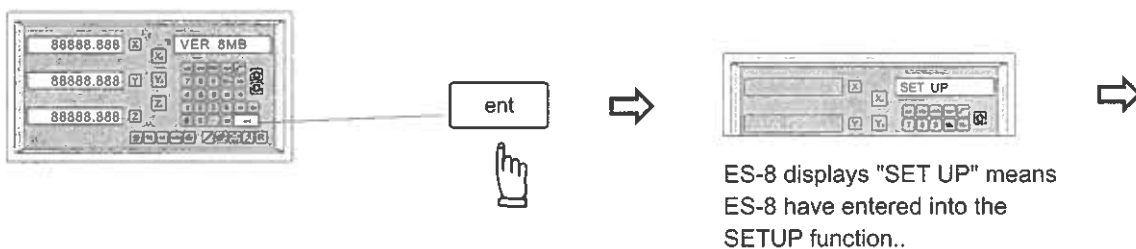
2) Switch on the **ES-8**, after switching on with the software version "VER. ***" showing in the **MESSAGE** window, press the number "ent" key to enter the parameters reset function.



2) Press  or  key to select next function in the menu, the next function after the **SETUP** is "DIRECTN" which specifies the direction of count for each axis.



Parameters Setup Procedure

Press **ent** to select the "DIRECTN" entry function

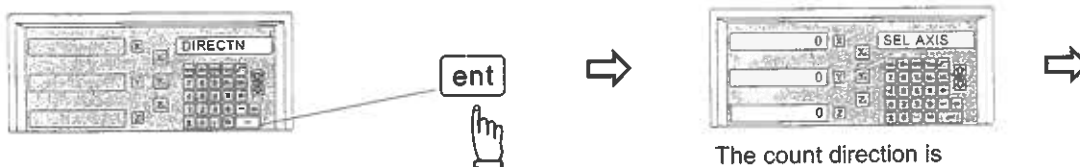

The count direction is represented by "0" or "1" in the axis display window.

The "0" represents a positive, 1 represents a negative. Press the "ent" key to make your selection.

For example, if you want to make a change in the count direction of X axis, procedure is as follows.

Press **X** or **X₀** to select the X axis, if current is "0", the count direction will be toggled to "1", same procedure applied to Y and Z axis.

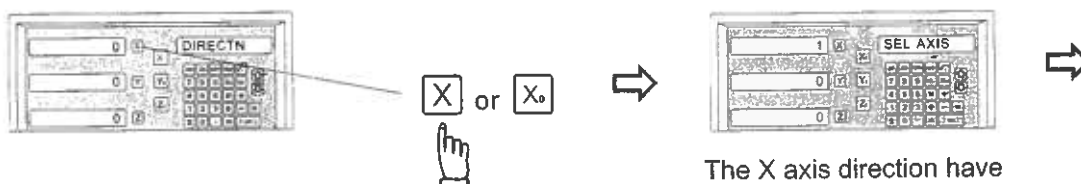

The X axis direction have been changed to "1" (negative).

then press **ent** to exit from the "DIRECTN" entry function to return to the top level menu.



3) Press **↓** or **↑** key to select next function in the menu, the next function after the "DIRECTN" is "LIN COMP" which specifies the linear compensation for each axis.



Parameters Setup Procedure

Press **ent** to select the "LIN COMP" entry function

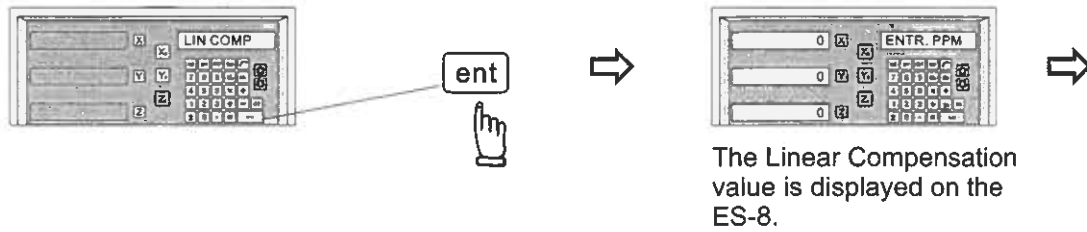

The Linear Compensation value is displayed on the ES-8.

The linear compensation value is specified in PPM [P(arts) P(er) M(illion)], method of calculation for PPM are as follows.

1. Measure the error using a step gauge or other device (e.g. gauge block) of an accuracy level on grade higher than the measuring step. If you are measuring on a 5um scale, the accuracy level of your measurement standard should be one grade higher ideally, such as 1um resolution or etc.
2. The error must be recorded in microns (um)
(e.g. we record an error of 19um over a length of 500mm)
3. Project the error over the 1 meter length (1000mm)
(e.g. in the above example, if measurement is 1 meter - 1000mm, the error will be $19\text{um} \times (1000/500) = 38\text{um}$)
4. Find the direction of error, if the DRO display longer than the step gauge, out compensation value is negative and vice versa.
5. The PPM value is micron error extrapolated over a meter , The M(illion) referred to in calculation is the 1 million microns to the meter.
(e.g. in our above example the entry would be 38)

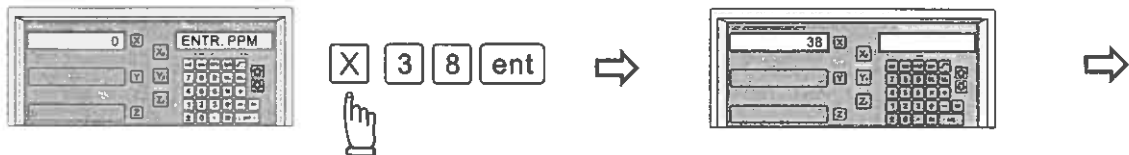

In the above example, the error measurement is in X axis, the DRO display shorter than the step gauge, therefore, the compensation value in PPM is +38. To entry this parameter into ES-8, procedures are as follows



then press **ent** to exit from the "LIN COMP" entry function to return to the top level menu.



Parameters Setup Procedure

- 4) Press  or  key to select next function in the menu, the next function after the "LIN COMP" is "Z DIAL" which specifies Z axis movement of the milling machine per Z axis Dial turn.

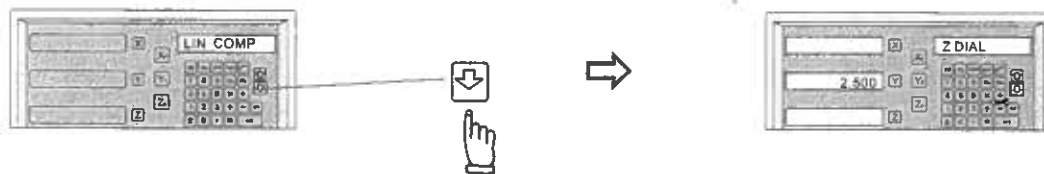

The Z Dial is the Z axis movement pre Dial turn. e.g. The Z movement per dial turn is 2.5 mm.

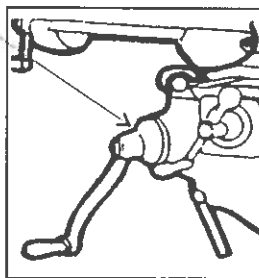

Press  to select the "Z DIAL" entry function

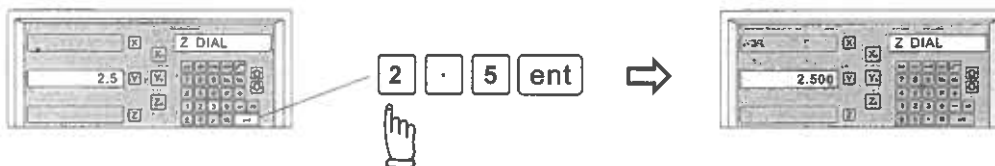
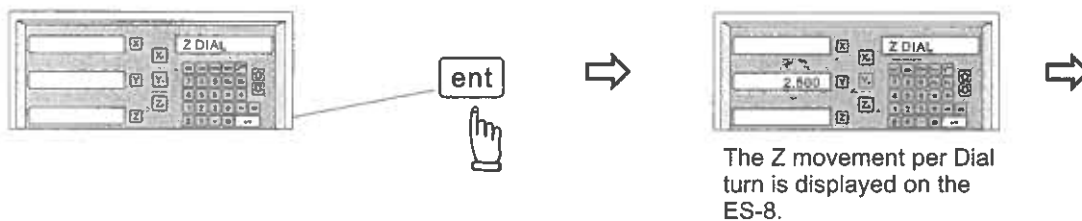

then press  to exit from the "Z DIAL" entry function to return to the top level menu.



Parameters Setup Procedure

5) Press  or  key to select next function in the menu, the next function after the "Z DIAL" is "DIAL INC" which specifies Z axis dial increment of the milling.

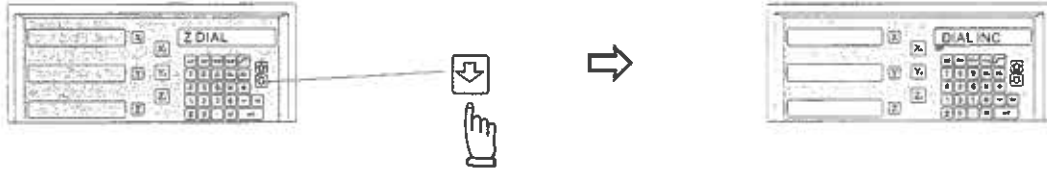

The DIAL INC is the increment step of the Z axis dial of milling machine. e.g. The DIAL INC is 0.02mm.

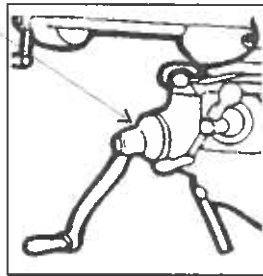

Press  to select the "DIAL INC" entry function

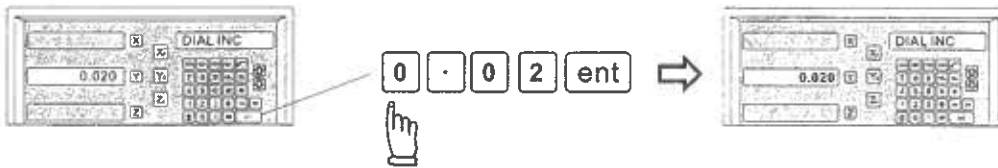
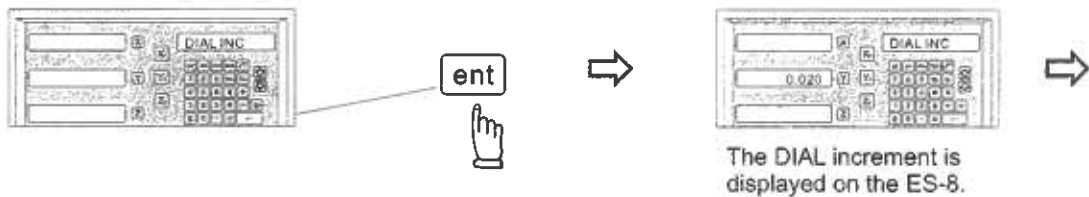

then press  to exit from the "DIAL INC" entry function to return to the top level menu.



Parameters Setup Procedure

6) Press  or  key to select next function in the menu, the next function after the "DIAL INC" is "R MODE" which specifies the Z axis interpolation method during the ARC function.



The ARC function of the ES-8 have two method of interpolation, they are "Z STEP" and "MAX CUT" as per follows.

Z STEP

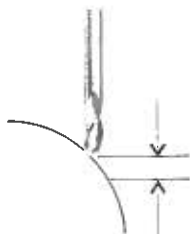

Z STEP mode, the Z axis interpolate in a fixed Z axis increment, it is easier and quicker for ARC machining, however, the machined work piece is not smooth.

MAX CUT

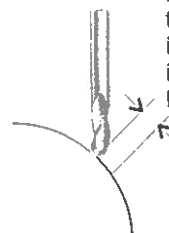
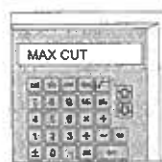

MAX CUT mode, the Z axis interpolation in fixed machine length, it is more time consuming, but the work piece is smoother

Press "ent" to enter into the R MODE select, then press "up" or "down" key to select the "Z STEP" or "MAX CUT" interpolation method. press the "ent" key to confirm the selection (e.g. To select the "Z STEP" in the example listed below)

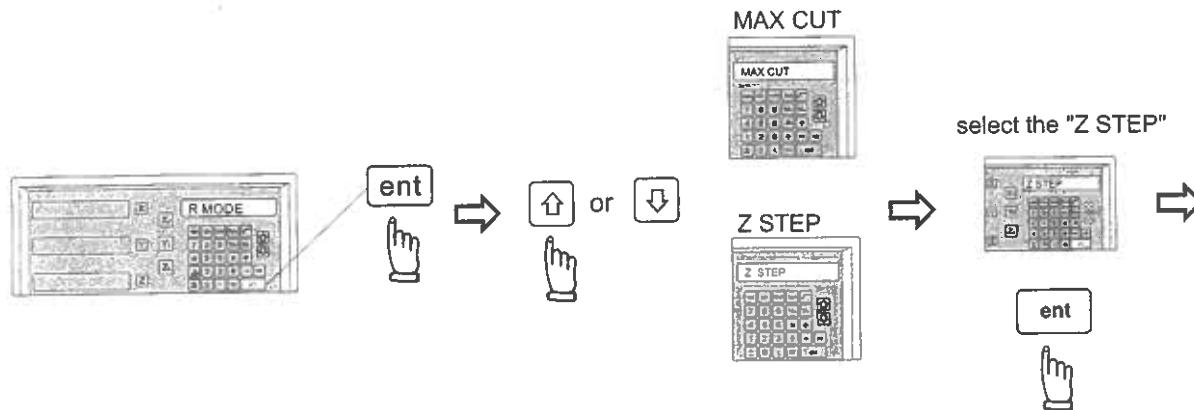

Parameters Setup Procedure

then press **ent** to exit from the "R MODE" entry function to return to the top level menu.

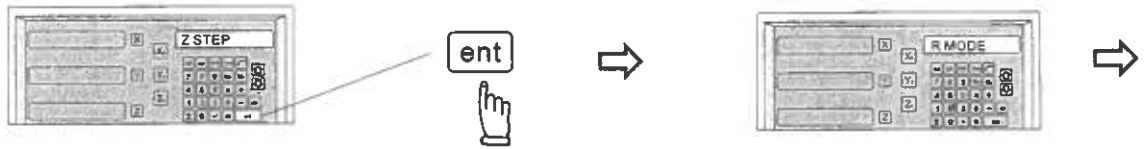

74) Press **↓** or **↑** key to select next function in the menu, the next function after the "R MODE" is "QUIT" exits the SETUP function to proceed to normal working.

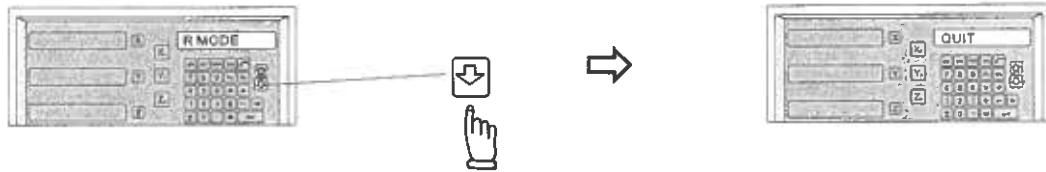

press **ent** to quit from the SETUP function.

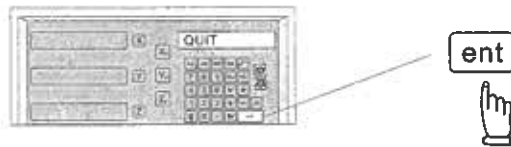

Please notice that the ES-8 must be switched off after quit from the setup function, otherwise, the new parameters setting will not effected.